

MAGSPRING

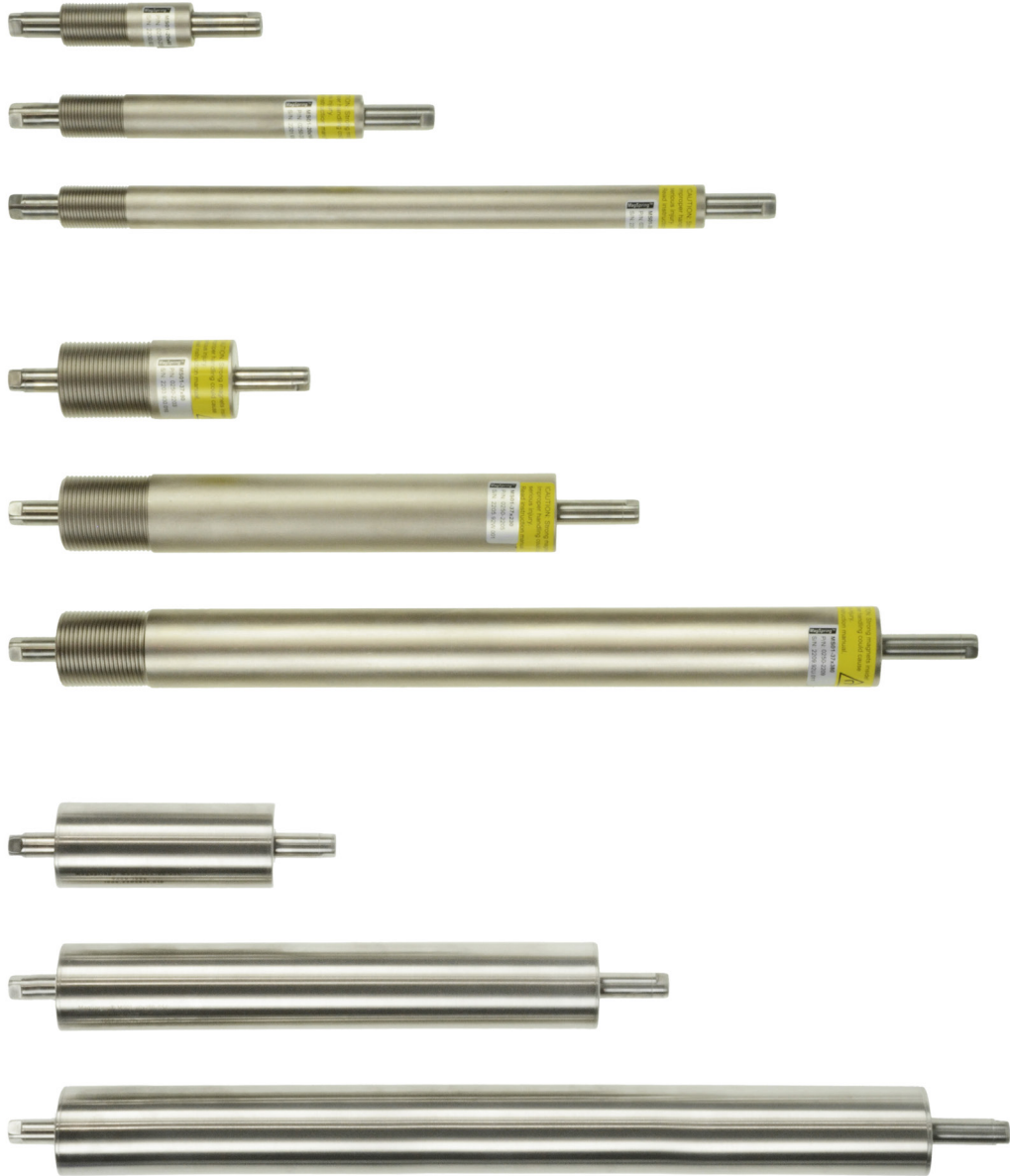

MagSpring products can best be described as "magnetic springs." The term "spring", however, is to be understood to mean that MagSpring components generate a constant force over their entire working range, while the characteristic curve for a typical mechanical spring shows an

increase in force with increasing displacement. The generation of force that is independent of the stroke makes MagSprings preferable for balancing weight forces in vertical drive applications.

Mode of operation

The mode of operation is based on the attractive force of permanent magnets. Accordingly, no energy source (electricity, compressed air, etc.) is needed. The special design of the flow-guiding components and the magnets translates the strongly non-linear relationship between force and displacement in magnet-iron arrangements into a constant force curve. Depending on the strength class of the MagSpring, the permanent magnets are either in the stator, in the slider, or in both components. The slider is guided by an integrated plain bearing, so that MagSprings can be used comparably to gas pressure springs in a design.

WEIGHT LOAD COMPENSATION

Linear motors and other direct drives must provide a constant force in vertical orientations, in order to oppose the weight load. Using a MagSpring installed in parallel with the linear motor, this weight load can be passively balanced. The linear motor is then only used for the actual positioning operation and dynamic forces, and can therefore be correspondingly smaller in design.

APPLICATION OF CONSTANT FORCE

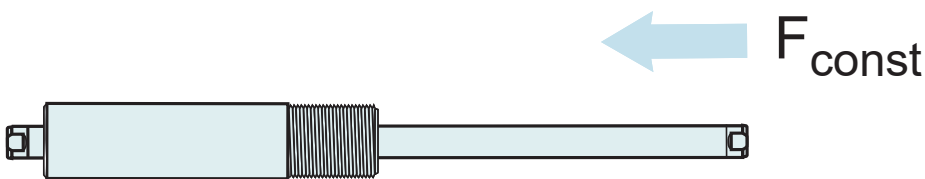

HOLDING FUNCTION (POWER OFF)

Since MagSprings are purely passive elements, a defined function or position of a device can be ensured in a power-off condition. For example, a gripper or press head on a vertical mount can be held up, or a slider can be pushed in or pulled out with a constant force.

Thanks to the constant force-displacement curve, many other applications are possible, such as the generation of a constant press force, regardless of position; application of a constant holding force across a large stroke range; or single-sided force support in drive applications. The effective force is in the range of +/- 10% of the nominal force, due to material and manufacturing tolerances.

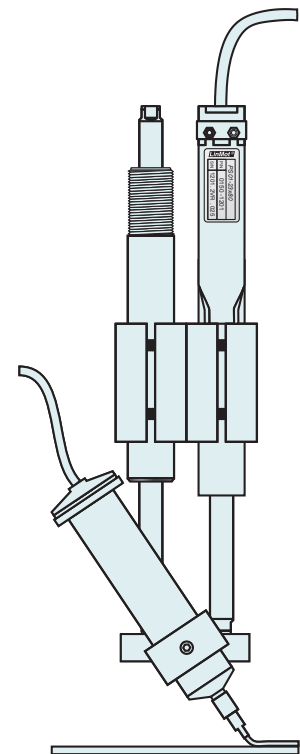

MagSpring ©

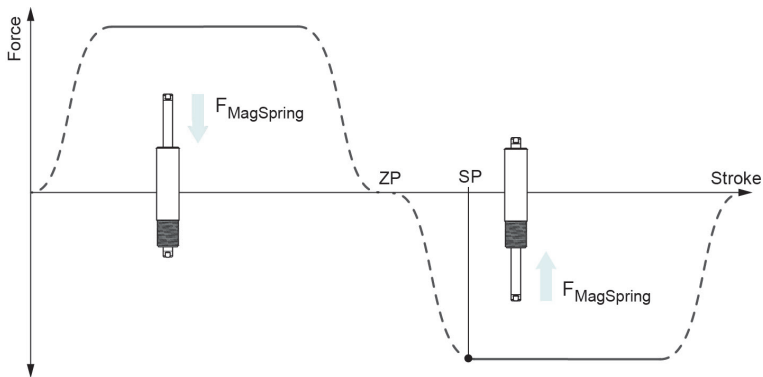

Mechanical Spring

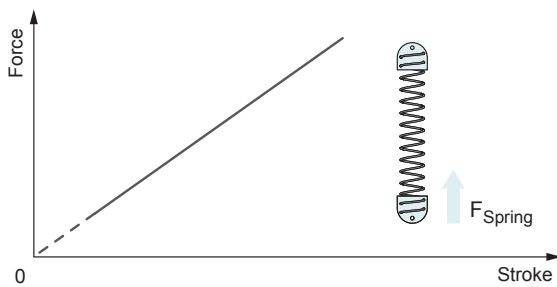

Working Range

In the relaxed state, the slider is approximately centered in the stator, while the working end of the slider extends somewhat out of the end of the stator. Fundamentally, however, both ends of the slider can be used to mount loads. From this rest position, the slider can be pulled or pushed out of the stator in both directions. The force increases from zero to the nominal force within a short stroke length. The working stroke then continues with a constant force. The start position (SP) describes the distance between the working end of the slider and the end of the stator at the beginning of the constant force range.



MOUNTING

The stators can be mounted via the screw thread, or with a clamp, as desired. There are appropriate mounting flanges for both sizes. When attaching the slider to the load mass, care should be taken that any parallelism errors are compensated for with a flexible coupler.

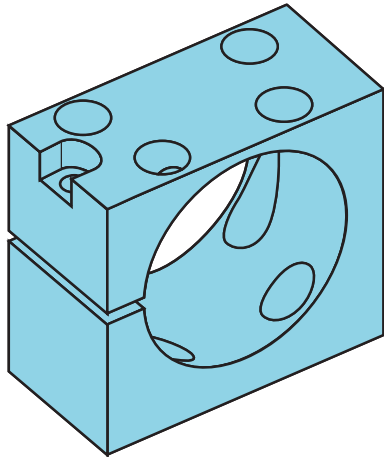
**COMBINATION WITH H-GUIDES**

The illustration on the page before shows a vertical arrangement of an H01 linear guide together with a MagSpring. The MagSpring presses upward with a constant force. The weight load is balanced by the MagSpring, and the linear motor thus bears less load. If the electrical power supply is interrupted, the MagSpring supports the load, or moves it into a safe waiting position.

MATERIALS

12

Slider:

Chromium-Nickel Steel 1.4301

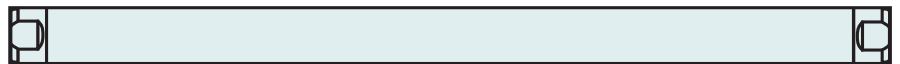
**Stator:**

Iron, electroless nickel plated

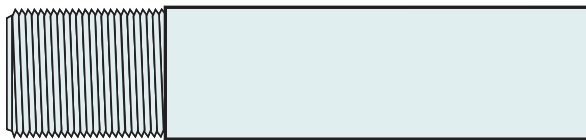
**Bearing:**

POM based



MagSpring

M01-20



- ✓ Constant force along the entire stroke
- ✓ Stroke up to 290 mm
- ✓ Force up to 22 N
- ✓ Purely passive, no electricity needed nor compressed air
- ✓ Ideal for compensating the gravitational force
- ✓ Also suitable for dynamic movements
- ✓ Compatible with H-guides

M01-20x60/50: FORCE 11-22N / STROKE 50 mm

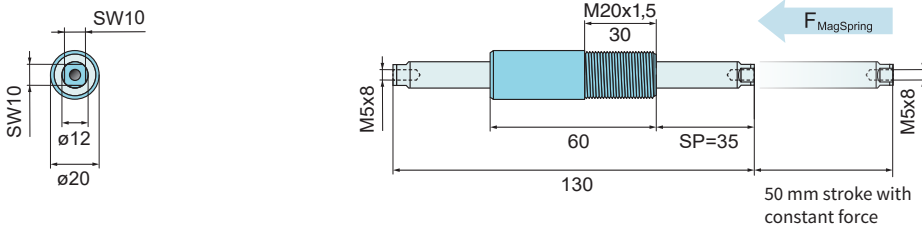

Dimensions in mm

The MagSpring has a constant force, as soon as the slider has been pulled out or pushed by the distance SP. The distance SP is measured between the unmarked slider end and the end of the stator (threaded end). The operating temperature range of the MagSpring is from -20°C to 80°C. The constant force of the MagSpring decreases slightly with increasing temperature or increases slightly with decreasing temperature. The temperature coefficient is -0.0022/°C.

MagSpring	Constant force [N]	Stator mass [g (lb)]	Slider mass [g (lb)]
M01-20x60/50-11	11	75 (0.16)	75 (0.16)
M01-20x60/50-17	17	75 (0.16)	75 (0.16)
M01-20x60/50-22	22	75 (0.16)	75 (0.16)

M01-20x140/130: FORCE 11-22N / STROKE 130 mm

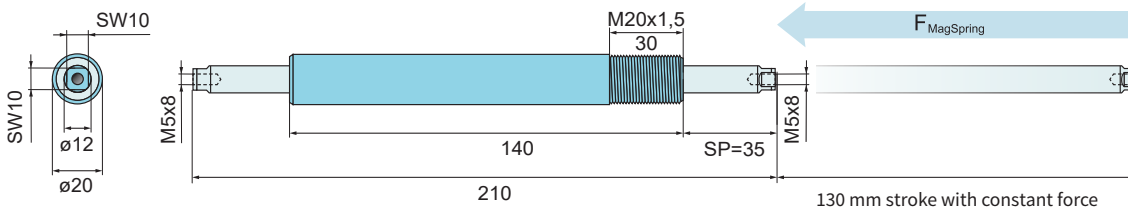

Dimensions in mm

The MagSpring has a constant force, as soon as the slider has been pulled out or pushed by the distance SP. The distance SP is measured between the unmarked slider end and the end of the stator (threaded end). The operating temperature range of the MagSpring is from -20°C to 80°C. The constant force of the MagSpring decreases slightly with increasing temperature or increases slightly with decreasing temperature. The temperature coefficient is -0.0022/°C.

MagSpring	Constant force [N]	Stator mass [g (lb)]	Slider mass [g (lb)]
M01-20x140/130-11	11	180 (0.39)	155 (0.34)
M01-20x140/130-17	17	180 (0.39)	155 (0.34)
M01-20x140/130-22	22	180 (0.39)	155 (0.34)

M01-20x220/210: FORCE 11-22N / STROKE 210 mm

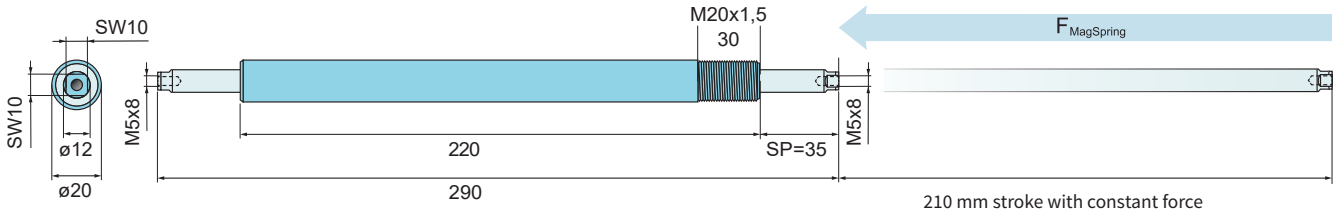

Dimensions in mm

The MagSpring has a constant force, as soon as the slider has been pulled out or pushed by the distance SP. The distance SP is measured between the unmarked slider end and the end of the stator (threaded end). The operating temperature range of the MagSpring is from -20°C to 80°C. The constant force of the MagSpring decreases slightly with increasing temperature or increases slightly with decreasing temperature. The temperature coefficient is -0.0022/°C.

MagSpring	Constant force [N]	Stator mass [g (lb)]	Slider mass [g (lb)]
M01-20x220/210-11	11	285 (0.62)	220 (0.49)
M01-20x220/210-17	17	285 (0.62)	220 (0.49)
M01-20x220/210-22	22	285 (0.62)	220 (0.49)

12

M01-20x300/290: FORCE 11-22N / STROKE 290 mm

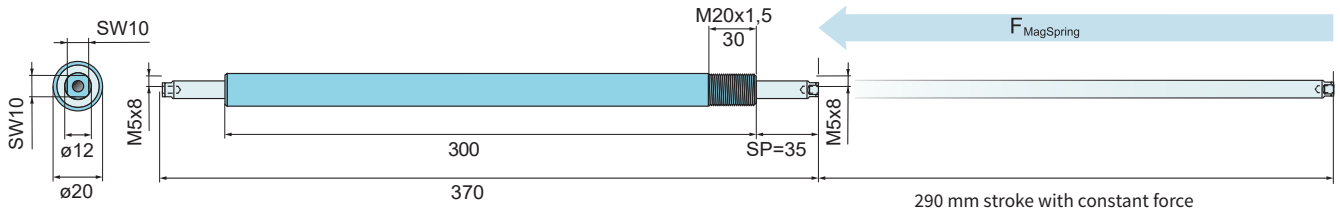

The MagSpring has a constant force, as soon as the slider has been pulled out or pushed by the distance SP.

The distance SP is measured between the unmarked slider end and the end of the stator (threaded end).

Dimensions in mm

The operating temperature range of the MagSpring is from -20°C to 80°C. The constant force of the MagSpring decreases slightly with increasing temperature or increases slightly with decreasing temperature. The temperature coefficient is -0.0022/°C.

MagSpring	Constant force [N]	Stator mass [g (lb)]	Slider mass [g (lb)]
M01-20x300/290-11	11	388 (0.86)	280 (0.61)
M01-20x300/290-17	17	388 (0.86)	280 (0.61)
M01-20x300/290-22	22	388 (0.86)	280 (0.61)

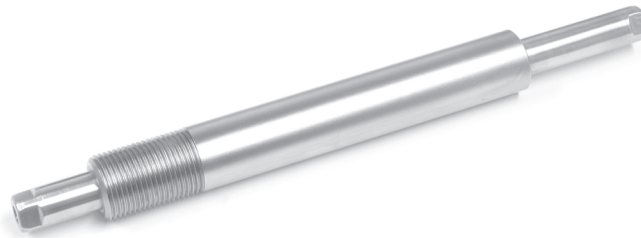

ORDERING INFORMATION

M01-20x60/50		MagSpring M01-20 with 50 mm stroke		
→	Stator	MS01-20x60	MagSpring Stator 20x60 mm	0250-2200
	Slider	ML01-12x130/80-10	Slider for MagSpring M01-20x60/50, Force 11N	0250-2300
		ML01-12x130/80-15	Slider for MagSpring M01-20x60/50, Force 17N	0250-2308
		ML01-12x130/80-20	Slider for MagSpring M01-20x60/50, Force 22N	0250-2301
M01-20x140/130		MagSpring M01-20 with 130 mm stroke		
→	Stator	MS01-20x140	MagSpring Stator 20x140 mm	0250-2201
	Slider	ML01-12x210/160-10	Slider for MagSpring M01-20x140/130, Force 11N	0250-2302
		ML01-12x210/160-15	Slider for MagSpring M01-20x140/130, Force 17N	0250-2309
		ML01-12x210/160-20	Slider for MagSpring M01-20x140/130, Force 22N	0250-2303
M01-20x220/210		MagSpring M01-20 with 210 mm stroke		
→	Stator	MS01-20x220	MagSpring Stator 20x220 mm	0250-2202
	Slider	ML01-12x290/240-10	Slider for MagSpring M01-20x220/210, Force 11N	0250-2304
		ML01-12x290/240-15	Slider for MagSpring M01-20x220/210, Force 17N	0250-2310
		ML01-12x290/240-20	Slider for MagSpring M01-20x220/210, Force 22N	0250-2305
M01-20x300/290		MagSpring M01-20 with 290 mm stroke		
→	Stator	MS01-20x300	MagSpring Stator 20x300 mm	0250-2207
	Slider	ML01-12x370/320-10	Slider for MagSpring M01-20x300/290, Force 11N	0250-2311
		ML01-12x370/320-15	Slider for MagSpring M01-20x300/290, Force 17N	0250-2312
		ML01-12x370/320-20	Slider for MagSpring M01-20x300/290, Force 22N	0250-2313

MagSpring M01-37



12

- ✓ Constant force along the entire stroke
- ✓ Stroke up to 350 mm
- ✓ Force up to 60 N
- ✓ Purely passive, no electricity needed nor compressed air
- ✓ Ideal for compensating the gravitational force
- ✓ Also suitable for dynamic movements
- ✓ Compatible with H-guides

M01-37x80/50: FORCE 40-60N / STROKE 50 mm

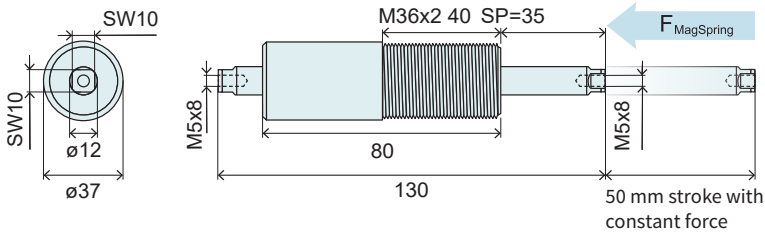

The MagSpring has a constant force, as soon as the slider has been pulled out or pushed by the distance SP. The distance SP is measured between the unmarked slider end and the end of the stator (threaded end). The operating temperature range of the MagSpring is from -20°C to 80°C. The constant force of the MagSpring decreases slightly with increasing temperature or increases slightly with decreasing temperature. The temperature coefficient is -0.0022/°C.

Dimensions in mm

MagSpring	Constant force [N]	Stator mass [g (lb)]	Slider mass [g (lb)]
M01-37x80/50-40	40	440 (0.90)	75 (0.16)
M01-37x80/50-50	50	440 (0.90)	75 (0.16)
M01-37x80/50-60	60	440 (0.90)	75 (0.16)

M01-37x155/125: FORCE 40-60N / STROKE 125 mm

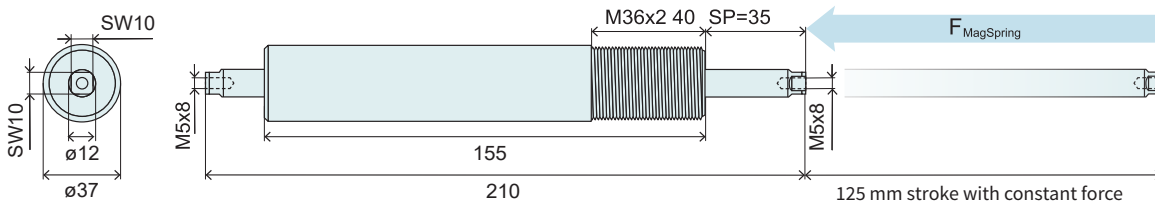

The MagSpring has a constant force, as soon as the slider has been pulled out or pushed by the distance SP. The distance SP is measured between the unmarked slider end and the end of the stator (threaded end). The operating temperature range of the MagSpring is from -20°C to 80°C. The constant force of the MagSpring decreases slightly with increasing temperature or increases slightly with decreasing temperature. The temperature coefficient is -0.0022/°C.

Dimensions in mm

MagSpring	Constant force [N]	Stator mass [g (lb)]	Slider mass [g (lb)]
M01-37x155/125-40	40	880 (1.80)	155 (0.34)
M01-37x155/125-50	50	880 (1.80)	155 (0.34)
M01-37x155/125-60	60	880 (1.80)	155 (0.34)

12

M01-37x230/200: FORCE 40-60N / STROKE 200 mm

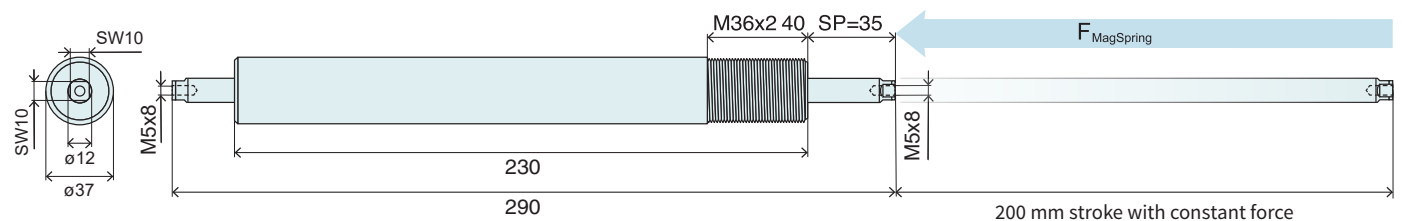

The MagSpring has a constant force, as soon as the slider has been pulled out or pushed by the distance SP. The distance SP is measured between the unmarked slider end and the end of the stator (threaded end). The operating temperature range of the MagSpring is from -20°C to 80°C. The constant force of the MagSpring decreases slightly with increasing temperature or increases slightly with decreasing temperature. The temperature coefficient is -0.0022/°C.

Dimensions in mm

MagSpring	Constant force [N]	Stator mass [g (lb)]	Slider mass [g (lb)]
M01-37x230/200-40	40	1320 (2.70)	220 (0.49)
M01-37x230/200-50	50	1320 (2.70)	220 (0.49)
M01-37x230/200-60	60	1320 (2.70)	220 (0.49)

M01-37x305/275: FORCE 40-60N / STROKE 275 mm

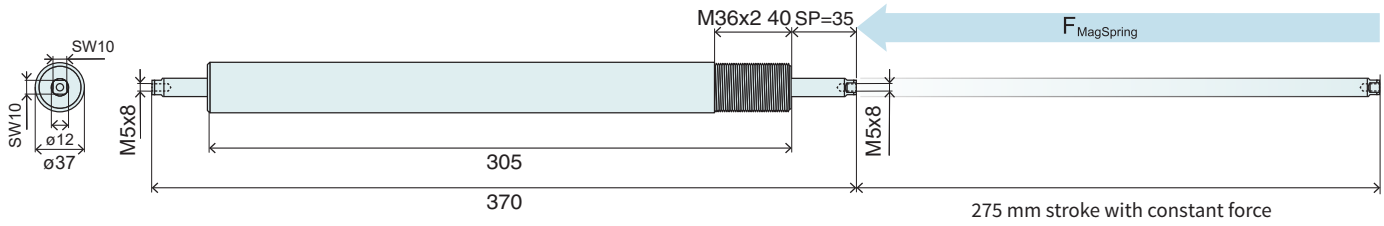

The MagSpring has a constant force, as soon as the slider has been pulled out or pushed by the distance SP. The distance SP is measured between the unmarked slider end and the end of the stator (threaded end). Dimensions in mm
 The operating temperature range of the MagSpring is from -20°C to 80°C. The constant force of the MagSpring decreases slightly with increasing temperature or increases slightly with decreasing temperature. The temperature coefficient is -0.0022/°C.

MagSpring	Constant force [N]	Stator mass [g (lb)]	Slider mass [g (lb)]
M01-37x305/275-40	40	1800 (3.90)	280 (0.61)
M01-37x305/275-50	50	1800 (3.90)	280 (0.61)
M01-37x305/275-60	60	1800 (3.90)	280 (0.61)

M01-37x380/350: FORCE 60N / STROKE 350 mm

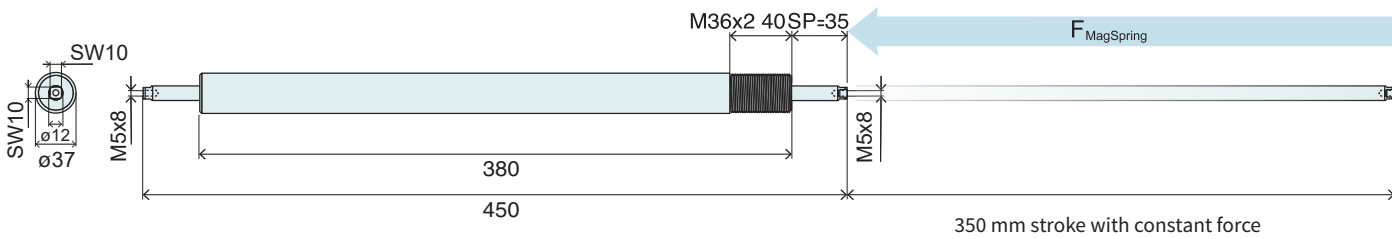

The MagSpring has a constant force, as soon as the slider has been pulled out or pushed by the distance SP. The distance SP is measured between the unmarked slider end and the end of the stator (threaded end). Dimensions in mm
 The operating temperature range of the MagSpring is from -20°C to 80°C. The constant force of the MagSpring decreases slightly with increasing temperature or increases slightly with decreasing temperature. The temperature coefficient is -0.0022/°C.

MagSpring	Constant force [N]	Stator mass [g (lb)]	Slider mass [g (lb)]
M01-37x380/350-60	60	2200 (4.85)	420 (0.93)

12



ORDERING INFORMATION

M01-37x80/50		MagSpring M01-37 with 50 mm stroke			
→	Stator	MS01-37x80	MagSpring Stator 37x80mm		0250-2203
	Slider	ML01-12x130/80-10	Slider for MagSpring M01-37x80/50, Force 40N		0250-2300
		ML01-12x130/80-15	Slider for MagSpring M01-37x80/50, Force 50N		0250-2308
		ML01-12x130/80-20	Slider for MagSpring M01-37x80/50, Force 60N		0250-2301
M01-37x155/125		MagSpring M01-37 with 125 mm stroke			
→	Stator	MS01-37x155	MagSpring Stator 37x155mm		0250-2204
	Slider	ML01-12x210/160-10	Slider for MagSpring M01-37x155/125, Force 40N		0250-2302
		ML01-12x210/160-15	Slider for MagSpring M01-37x155/125, Force 50N		0250-2309
		ML01-12x210/160-20	Slider for MagSpring M01-37x155/125, Force 60N		0250-2303
M01-37x230/200		MagSprings M01-37 with 200 mm stroke			
→	Stator	MS01-37x230	MagSpring Stator 37x230mm		0250-2205
	Slider	ML01-12x290/240-10	Slider for MagSpring M01-37x230/200, Force 40N		0250-2304
		ML01-12x290/240-15	Slider for MagSpring M01-37x230/200, Force 50N		0250-2310
		ML01-12x290/240-20	Slider for MagSpring M01-37x230/200, Force 60N		0250-2305
M01-37x305/275		MagSprings M01-37 with 275 mm stroke			
→	Stator	MS01-37x305	MagSpring Stator 37x305mm		0250-2206
	Slider	ML01-12x370/320-10	Slider for MagSpring M01-37x305/275, Force 40N		0250-2311
		ML01-12x370/320-15	Slider for MagSpring M01-37x305/275, Force 50N		0250-2312
		ML01-12x370/320-20	Slider for MagSpring M01-37x305/275, Force 60N		0250-2313
M01-37x380/350		MagSpring M01-37 with stroke 350 mm			
→	Stator	MS01-37x380	MagSpring Stator 37x380mm		0250-2209
	Slider	ML01-12x450/400-20	Slider for MagSpring M01-37x380/350, Force 60N		0250-2332

A series of horizontal dotted lines spanning the width of the page, intended for taking notes.

MagSpring

M01-40-SSC



- ✓ Stainless steel design of the proven MagSpring
- ✓ Constant force along the entire stroke
- ✓ Stroke up to 350 mm
- ✓ Force up to 60 N
- ✓ Purely passive, no electricity needed nor compressed air
- ✓ Ideal for compensating the gravitational force
- ✓ Also suitable for dynamic movements

M01-40x100-SSC/50: FORCE 40-60N / STROKE 50 mm

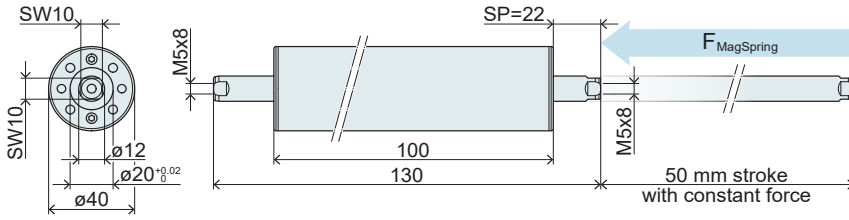

The MagSpring has a constant force, as soon as the slider has been pulled out or pushed by the distance SP. The distance SP is measured between the unmarked slider end and the end of the stator (threaded end). The operating temperature range of the MagSpring is from -20°C to 80°C. The constant force of the MagSpring decreases slightly with increasing temperature or increases slightly with decreasing temperature. The temperature coefficient is -0.0022/°C.

Dimensions in mm

MagSpring	Constant force [N]	Stator mass [g (lb)]	Slider mass [g (lb)]
M01-40x100-SSC/50-40	40	440 (0.90)	75 (0.16)
M01-40x100-SSC/50-50	50	440 (0.90)	75 (0.16)
M01-40x100-SSC/50-60	60	440 (0.90)	75 (0.16)

M01-40x175-SSC/125: FORCE 40-60N / STROKE 125 mm

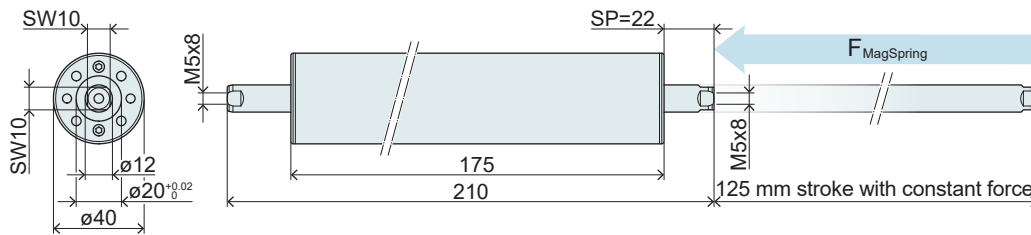

The MagSpring has a constant force, as soon as the slider has been pulled out or pushed by the distance SP. The distance SP is measured between the unmarked slider end and the end of the stator (threaded end). The operating temperature range of the MagSpring is from -20°C to 80°C. The constant force of the MagSpring decreases slightly with increasing temperature or increases slightly with decreasing temperature. The temperature coefficient is -0.0022/°C.

Dimensions in mm

MagSpring	Constant force [N]	Stator mass [g (lb)]	Slider mass [g (lb)]
M01-40x175-SSC/125-40	40	880 (1.80)	155 (0.34)
M01-40x175-SSC/125-50	50	880 (1.80)	155 (0.34)
M01-40x175-SSC/125-60	60	880 (1.80)	155 (0.34)

M01-40x250-SSC/200: FORCE 40-60N / STROKE 200 mm

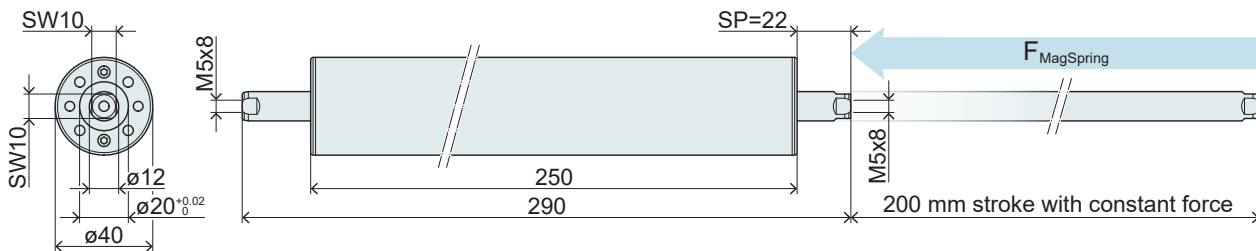

The MagSpring has a constant force, as soon as the slider has been pulled out or pushed by the distance SP. The distance SP is measured between the unmarked slider end and the end of the stator (threaded end). The operating temperature range of the MagSpring is from -20°C to 80°C. The constant force of the MagSpring decreases slightly with increasing temperature or increases slightly with decreasing temperature. The temperature coefficient is -0.0022/°C.

Dimensions in mm

MagSpring	Constant force [N]	Stator mass [g (lb)]	Slider mass [g (lb)]
M01-40x250-SSC/200-40	40	1320 (2.70)	220 (0.49)
M01-40x250-SSC/200-50	50	1320 (2.70)	220 (0.49)
M01-40x250-SSC/200-60	60	1320 (2.70)	220 (0.49)

M01-40x325-SSC/275: FORCE 40-60N / STROKE 275 mm

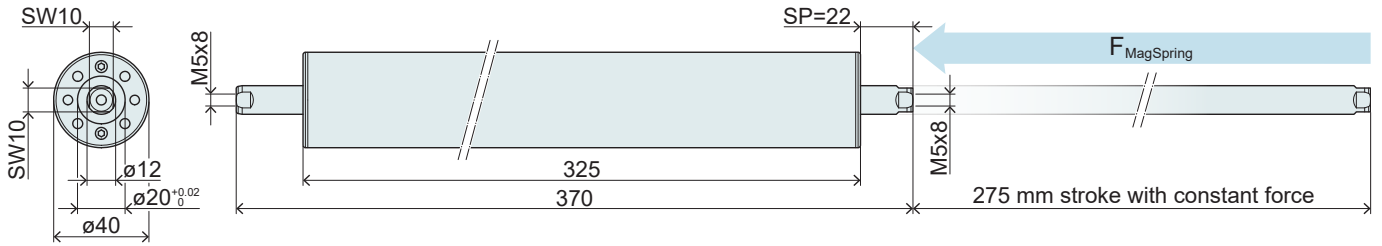

The MagSpring has a constant force, as soon as the slider has been pulled out or pushed by the distance SP. The distance SP is measured between the unmarked slider end and the end of the stator (threaded end). The operating temperature range of the MagSpring is from -20°C to 80°C. The constant force of the MagSpring decreases slightly with increasing temperature or increases slightly with decreasing temperature. The temperature coefficient is -0.0022/°C.

Dimensions in mm

MagSpring	Constant force [N]	Stator mass [g (lb)]	Slider mass [g (lb)]
M01-40x325-SSC/275-40	40	1800 (3.90)	280 (0.61)
M01-40x325-SSC/275-50	50	1800 (3.90)	280 (0.61)
M01-40x325-SSC/275-60	60	1800 (3.90)	280 (0.61)

M01-40x400-SSC/350: FORCE 60N / STROKE 350 mm

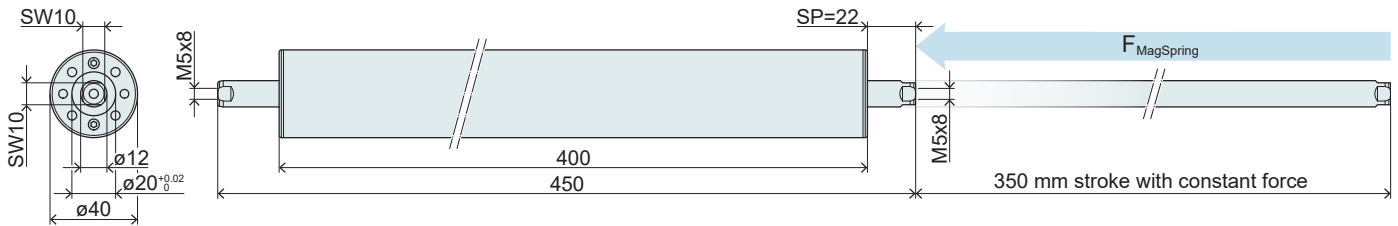

The MagSpring has a constant force, as soon as the slider has been pulled out or pushed by the distance SP. The distance SP is measured between the unmarked slider end and the end of the stator (threaded end). The operating temperature range of the MagSpring is from -20°C to 80°C. The constant force of the MagSpring decreases slightly with increasing temperature or increases slightly with decreasing temperature. The temperature coefficient is -0.0022/°C.

Dimensions in mm

MagSpring	Constant force [N]	Stator mass [g (lb)]	Slider mass [g (lb)]
M01-40x400-SSC/350-60	60	2200 (4.85)	420 (0.93)

ASSEMBLY DRAWING

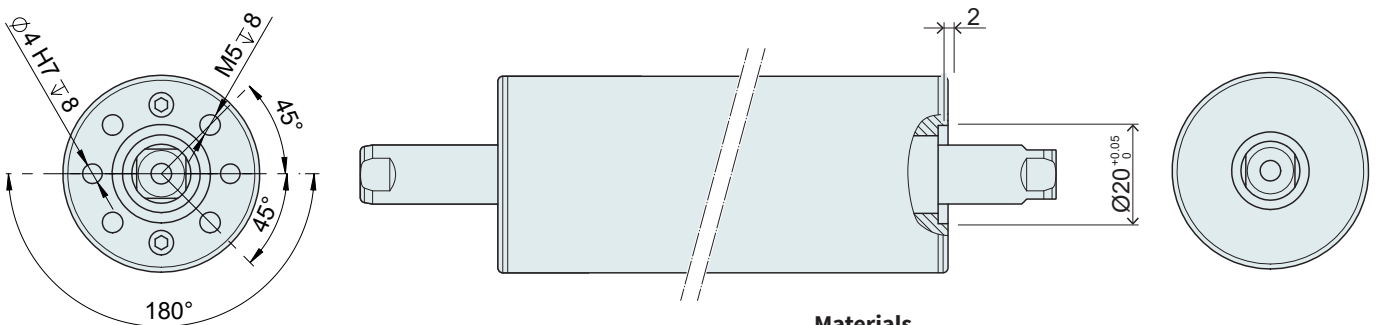

Materials
 Stator: Stainless steel 1.4404
 Stator plain bearing: Synthetical HPV PPS



ORDERING INFORMATION

M01-40x100-SSC/50	MagSpring M01-40-SSC with 50 mm stroke			
→	Stator	MS01-40x100-SSC	MagSpring SSC Stator 40x100mm	0250-1006
→	Slider	ML01-12x130/80-10	Slider for MagSpring M01-40x100/50, force 40N	0250-2300
		ML01-12x130/80-15	Slider for MagSpring M01-40x100/50, force 50N	0250-2308
		ML01-12x130/80-20	Slider for MagSpring M01-40x100/50, force 60N	0250-2301
M01-40x175-SSC/125	MagSpring M01-40-SSC with 125 mm stroke			
→	Stator	MS01-40x175-SSC	MagSpring SSC Stator 40x175mm	0250-1005
→	Slider	ML01-12x210/160-10	Slider for MagSpring M01-40x175-SSC/125, force 40N	0250-2302
		ML01-12x210/160-15	Slider for MagSpring M01-40x175-SSC/125, force 50N	0250-2309
		ML01-12x210/160-20	Slider for MagSpring M01-40x175-SSC/125, force 60N	0250-2303
M01-40x250-SSC/200	MagSprings M01-40-SSC with 200 mm stroke			
→	Stator	MS01-40x250-SSC	MagSpring SSC Stator 40x250mm	0250-1007
→	Slider	ML01-12x290/240-10	Slider for MagSpring M01-40x250-SSC/200, force 40N	0250-2304
		ML01-12x290/240-15	Slider for MagSpring M01-40x250-SSC/200, force 50N	0250-2310
		ML01-12x290/240-20	Slider for MagSpring M01-40x250-SSC/200, force 60N	0250-2305
M01-40x325-SSC/275	MagSprings M01-40-SSC with 275 mm stroke			
→	Stator	MS01-40x325-SSC	MagSpring SSC Stator 40x325mm	0250-1008
→	Slider	ML01-12x370/320-10	Slider for MagSpring M01-40x325-SSC/275, force 40N	0250-2311
		ML01-12x370/320-15	Slider for MagSpring M01-40x325-SSC/275, force 50N	0250-2312
		ML01-12x370/320-20	Slider for MagSpring M01-40x325-SSC/275, force 60N	0250-2313
M01-40x400-SSC/350	MagSpring M01-40-SSC with 350 mm stroke			
→	Stator	MS01-40x400-SSC	MagSpring SSC Stator 40x400mm	0250-1009
→	Slider	ML01-12x450/400-20	Slider for MagSpring M01-40x400-SSC/350, force 60N	0250-2332

Accessories

Mounting flanges and adaptors are available for mounting MagSpring magnetic springs. Using these accessories, the magnetic springs can be mounted directly on an H01 linear guide or a B01 bridge guide.

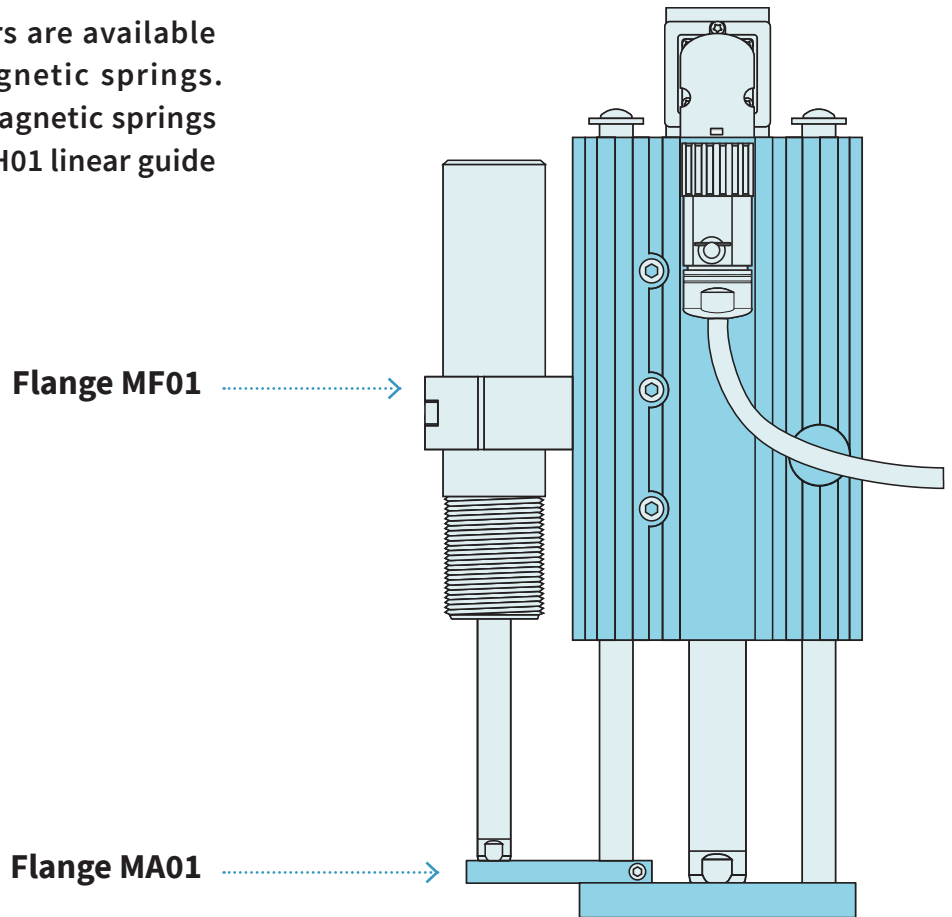

MOUNTING **MOTOR ON THE TOP** **MOTOR ON THE BOTTOM**

The flange for mounting the MagSpring stators is secured with T-nuts in the T-slot provided for this purpose on the linear or bridge guide.

For weight balancing in vertical installations, the lower slider end of the MagSpring is attached to the guide shaft of the guide using the Adaptor.

Depending on the installation orientation of the guide, the Adaptor is attached to the guide shaft at the front mounting plate (motor on top) or the rear end of the guide shaft (motor on the bottom).

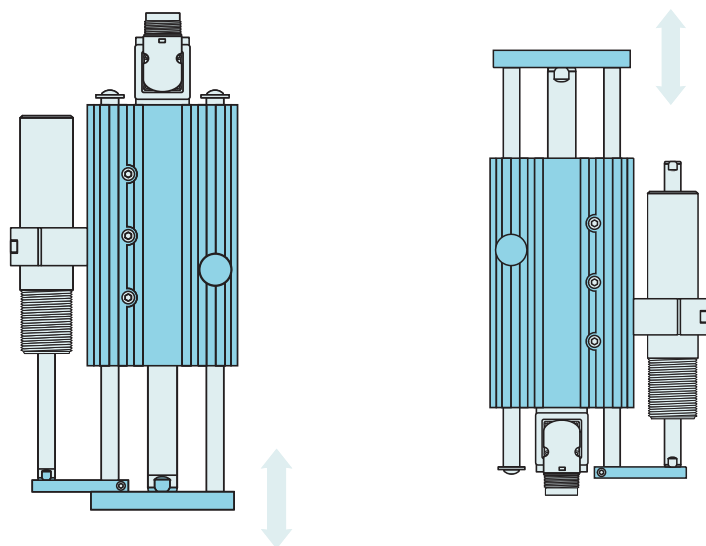

FLANGE AND ADAPTOR FOR MAGSPRING



FLANGES FOR MAGSPRING M01-20

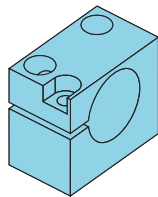
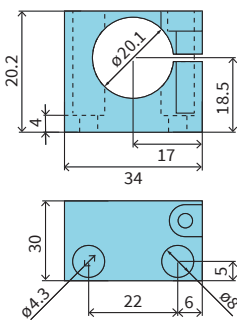

MF01-20/H23

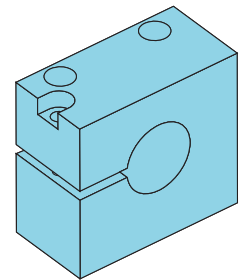
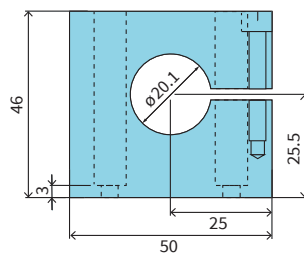

MF01-20/H37

Material: Aluminum (AlMgSi), black anodized
Mass: MF01-20/H23 approx. 30g (0.066lb)
 MF01-20/H37 approx. 125g (0.276lb)

Dimensions in mm

Item	Description	Item No.
MF01-20/H23	Flange MagSpring M01-20 - fits guides H01-23	0250-2306
MF01-20/H37	Flange MagSpring M01-20 - fits guides H01-37	0250-2315

FLANSCH UND ADAPTER FÜR MAGSPRING

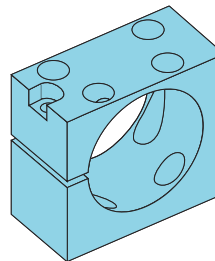
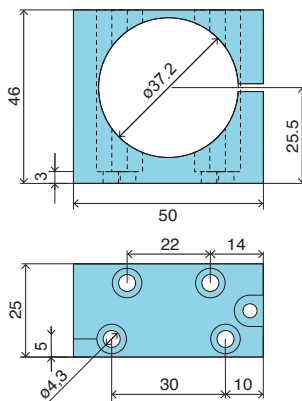

Dimensions in mm

Item	Description	Item No.
MF01-37/H37	Flange MagSpring M01-37 - fits guides H01-37 und B01-37 - fits guides H01-48 und B01-48	0250-2307

ADAPTOR FOR MAGSPRING M01-20 AND GUIDES H01-23

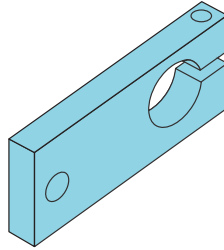
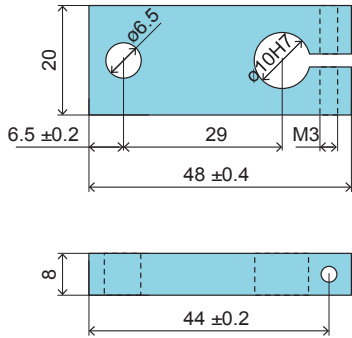

Material: Aluminum (AlMgSi), black anodized
Mass: approx. 18g (0.066lb)

Dimensions in mm

Item	Description	Item No.
MA01-20/H23	Adaptor MagSpring M01-20 / Guides H01-23	0250-0116

ADAPTOR FOR MAGSPRING M01-37 AND GUIDES H01-37 / B01-37

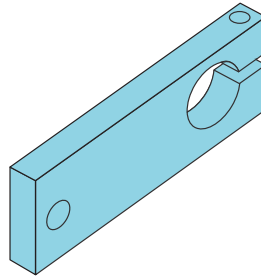
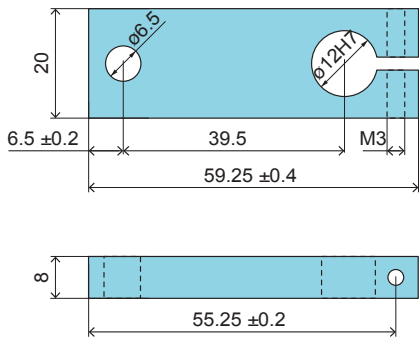

Material: Aluminum (AlMgSi), black anodize
Mass: approx. 18g (0.066lb)

Dimensions in mm

Item	Description	Item No.
MA01-37/H37	Adaptor MagSpring M01-37 / Guides H01-37 und B01-37	0250-0117

ADAPTOR FOR MAGSPRING M01-37 AND GUIDES H01-48 / B01-48

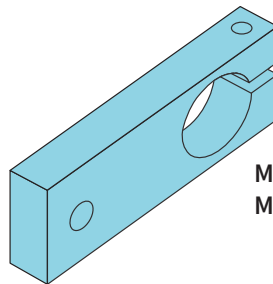
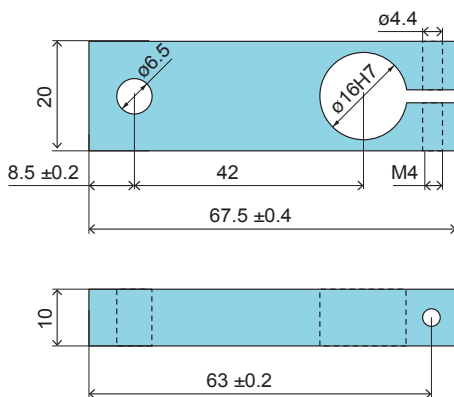

Material: Aluminum (AlMgSi), black anodize
Mass: approx. 32g (0.034lb)

Dimensions in mm

Item	Description	Item No.
MA01-37/H48	Adaptor MagSpring M01-37 / Guides H01-48 und B01-48	0250-0118

