

# Hardware Manual

## STR4 & STR8

### Step Motor Drives



920-0030L  
1/25/2018



## Contents

Introduction .....	3
Features .....	3
Block Diagram .....	4
Getting Started.....	5
Mounting the Drive.....	6
Connecting the Power Supply.....	6
Drive CE Requirements.....	7
Choosing a Power Supply.....	9
Voltage.....	9
Current.....	9
Connecting the Motor.....	12
Four Lead Motor .....	12
Eight Lead Motor.....	12
Connecting Input Signals.....	13
Connector Pin Diagram.....	13
Connection Examples: STEP & DIR .....	13
Internal Circuit Diagram.....	13
Connection Examples: EN.....	14
FAULT Output.....	16
Configuring the Drive.....	17
Step 1: Selecting a Motor .....	17
STR4 Motor Table.....	17
STR8 Motor Table.....	18
Step 2: Setting the Current .....	18
Step 3: Setting Idle Current.....	19
Step 4: Load Inertia.....	20
Step 5: Step Size.....	20
Step 6: Step Pulse Type.....	22
Step 7: Step Pulse Noise Filter.....	23
Self Test.....	24
Reference Materials.....	24
Motor Outlines.....	24
Torque-Speed Curves.....	27
Motor Heating.....	33
STR4 Maximum Motor Duty Cycle.....	34
STR8 Maximum Motor Duty .....	35
Drive Heating.....	42
Mechanical Outline .....	43
Technical Specifications.....	44
Mating Connectors and Accessories.....	45
Alarm Codes.....	46
Connector Diagrams.....	46

## Introduction

Thank you for selecting an Applied Motion Products motor drive. We hope our dedication to performance, quality and economy will make your motion control project successful.

If there's anything we can do to improve our products or help you use them better, please call us. We'd like to hear from you, our phone number is (800) 525-1609.

You can also email [support@applied-motion.com](mailto:support@applied-motion.com).

## Features

- Low cost, digital step motor driver in compact package
- Operates from Step & Direction signals or Step CW & Step CCW (jumper selectable)
- Enable input
- Fault output
- Optically isolated I/O
- Digital filters prevent position error from electrical noise on command signals
  - Jumper selectable: 150 kHz or 2 MHz
- Rotary switch easily selects from many popular motors
- Electronic damping and anti-resonance
- Automatic idle current reduction to reduce heat when motor is not moving
  - Switch selectable: 50% or 90% of running current
- Switch selectable step resolution: 200 (full step), 400 (half step), 2000, 5000, 12800 or 20000 steps/rev
- Switch selectable microstep emulation provides smoother, more reliable motion in full and half step modes
- Automatic self test (switch selectable)

## STR4

- Operates from a 24 to 48 volt DC power supply
- Running current up to 4.5 amps per phase

## STR8

- Operates from a 24 to 75 volt DC power supply
- Running current up to 7.8 amps per phase

## Block Diagram

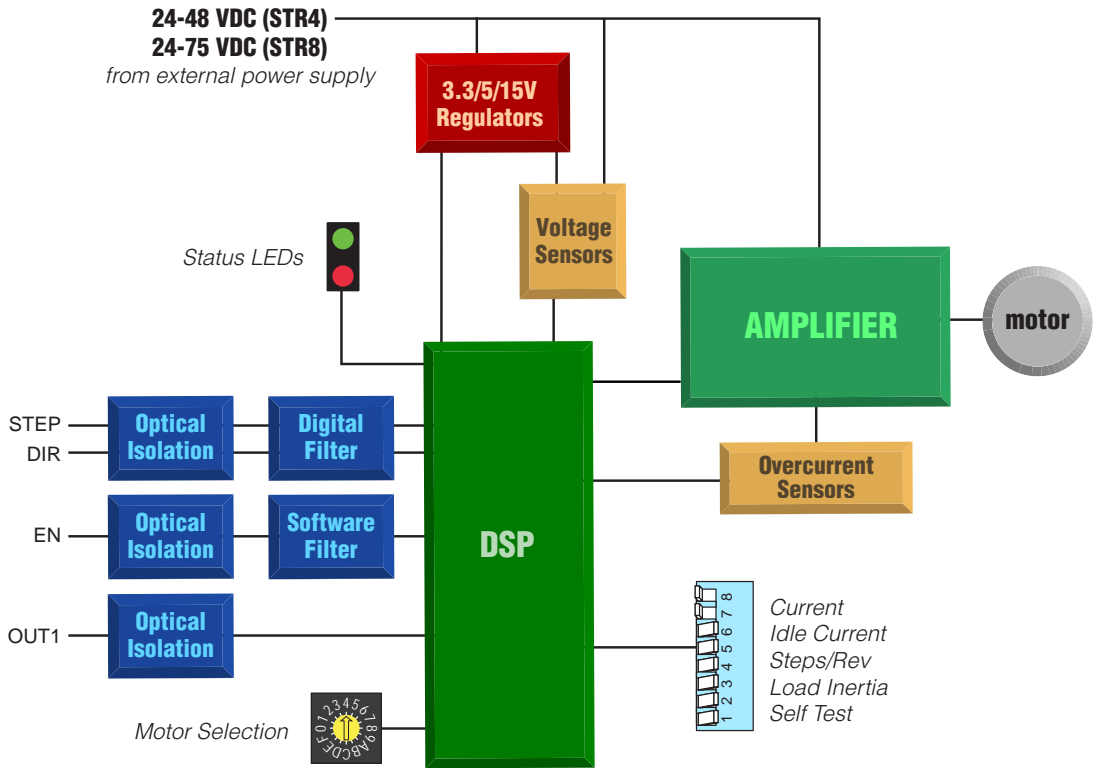

## Getting Started

This manual describes the use of two different drive models: the STR4 and STR8. They differ in maximum output current and maximum power supply voltage. For both models, you'll need the following:

- a 24 to 48 volt DC power supply (75V max for STR8). Please read the section *Choosing a Power Supply* for help in choosing the right power supply.
- one of the motors listed on the drive label (see section *Configuring the Drive*).
- a small flat blade screwdriver for tightening the connectors.
- a source of step signals, such as a PLC or motion controller.

The connectors and other points of interest are illustrated below. These are detailed later in the manual.

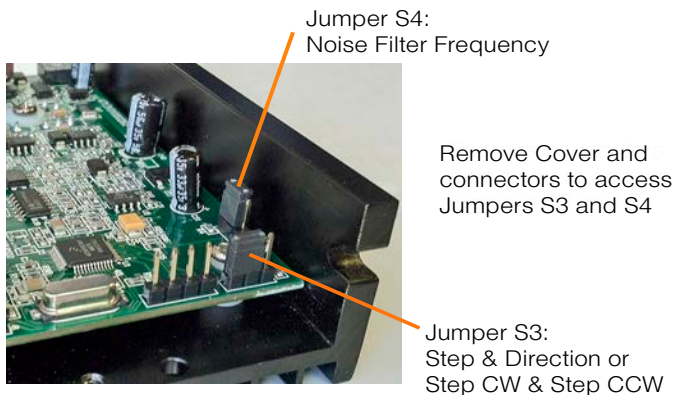
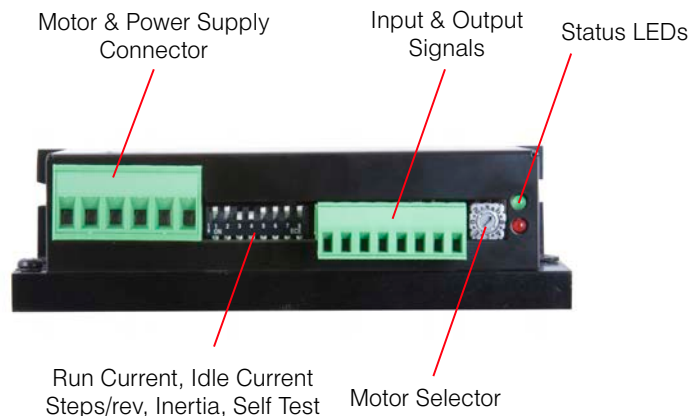

## Mounting the Drive

You can mount your drive on the wide or the narrow side of the chassis using #6 screws. If possible, the drive should be securely fastened to a smooth, flat metal surface that will help conduct heat away from the chassis. If this is not possible, then forced airflow from a fan may be required to prevent the drive from overheating. See page 40 for more details about drive heating.

- ***Never use your drive in a space where there is no air flow or where other devices cause the surrounding air to be more than 50°C.***
- ***Never put the drive where it can get wet or where metal or other electrically conductive particles can get on the circuitry.***
- ***Always provide air flow around the drive. When mounting multiple drives near each other, maintain at least one half inch of space between drives.***

## Connecting the Power Supply

If you need information about choosing a power supply, please read the section *Choosing a Power Supply*.

- Connect the power supply "+" terminal to the connector terminal labeled "V+".
- Connect power supply "-" to the connector terminal labeled "V-".
- The green ground screw on the corner of the chassis should be connected to earth ground.
- Use 18 or 20 gauge wire.

The STR drives contain an internal fuse that connects to the power supply + terminal. This fuse is not user replaceable. If you want to install a user serviceable fuse in your system install a fast acting fuse in line with the + power supply lead. Use a 4 amp fuse for the STR4 and a 7 amp fuse for the STR8. Some HT24 motors draw more than 4 amps, a 7 amp fuse is recommended for all drives in this case.



***Be careful not to reverse the wires. Reverse connection will destroy your drive, void your warranty and generally wreck your day.***

## Drive CE Requirements

CE requires you to use an EMI line filter, P/N:092.00823.00(LCR), installed as shown:

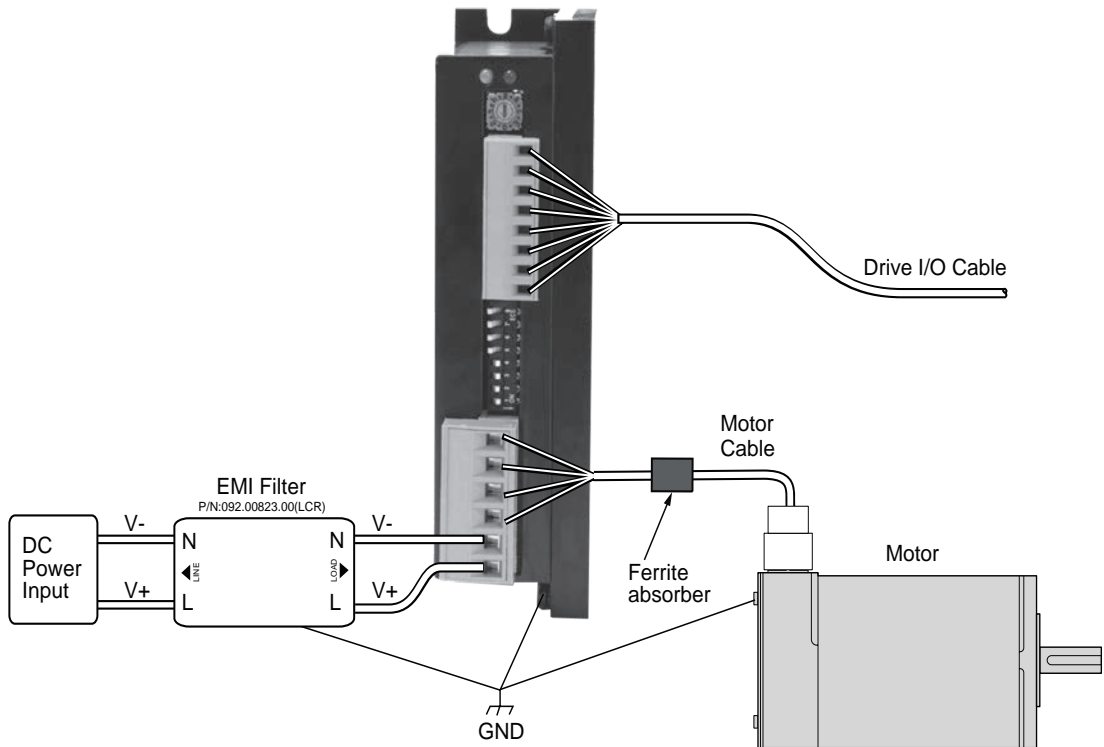



## Power Supply and Ground Connections

*Locate fuse in-line with "+" connection*

If you plan to use a regulated power supply you may encounter a problem with regeneration. If you rapidly decelerate a load from a high speed, much of the kinetic energy of that load is transferred back to the power supply. This can trip the overvoltage protection of a switching power supply, causing it to shut down. We offer the RC-050 "regeneration clamp" to solve this problem. If in doubt, buy an RC-050 for your first installation. If the "regen" LED on the RC-050 never flashes, you don't need the clamp.



regen LED

**RC-050 Regen Clamp**



## Choosing a Power Supply

When choosing a power supply, there are many things to consider. If you are manufacturing equipment that will be sold to others, you probably want a supply with all the safety agency approvals. If size and weight are an issue get a switching supply.

And you must decide what size of power supply (in terms of voltage and current) is needed for your application.

Applied Motion offers two powers supplies that are excellent matches for the STR4 and STR8 drives: PS150A24 (24V, 6.3A) and PS320A48 (48V, 6.7A).

## Voltage

Your motor can provide more torque at higher speeds if a higher power supply voltage is used. Please consult the speed-torque curves later in this manual for guidance.

If you choose an unregulated power supply, make sure the no load voltage of the supply does not exceed the drive's maximum input voltage specification.

## Current

The maximum supply current you could ever need is two times the motor current. However, you will generally need a lot less than that, depending on the motor type, voltage, speed and load conditions. That's because the STR uses a switching amplifier, converting a high voltage and low current into lower voltage and higher current. The more the power supply voltage exceeds the motor voltage, the less current you'll need from the power supply. A motor running from a 48 volt supply can be expected to draw only half the supply current that it would with a 24 volt supply.

We recommend the following selection procedure:

1. If you plan to use only a few drives, get a power supply with at least twice "per phase" current rating of the step motor. Example: for a motor that's rated for 2 A/phase use a 4 A power supply.
2. If you are designing for mass production and must minimize cost, get one power supply with more than twice the rated current of the motor. Install the motor in the application and monitor the current coming out of the power supply and into the drive at various motor loads. This will tell you how much current you really need so you can design in a lower cost

power supply.

The tables below and on the next page list the maximum current required for each motor at several common power supply voltages. Please consider this information when choosing a power supply.

**Table 1: STR4 Power Supply Current**

All motors connected as indicated, except HT24 which have four leads.

Switch	Motor	Drive Current Amps, peak of sine	Max Power Supply Current (A)	
			24VDC	48VDC
0	reserved for custom motors			
1				
2	HT17-278	2.4 parallel	1.6	1.7
3	HT17-068/268	1.6 parallel	1.1	1.1
4	HT17-071/271	2.0 parallel	1.1	1.1
5	HT17-075/275	2.0 parallel	1.1	1.1
6	HT23-394/594	3.4 parallel	1.9	2.0
7	HT23-398/598	4.5 parallel	3.2	3.3
8	HT23-401/601	4.5 parallel	3.2	3.4
9	HT24-100	3.36	2.6	2.3
A	HT24-105	4.5	5.2	3.2
B	HT24-108	4.5	4.3	3.4
C	HT34-485	4.5 series	2.6	2.5
D	HT34-486	4.5 series	2.4	2.7
E	HT34-504	3.816 series	2.1	2.1
F	HT34-505	3.816 series	2.4	2.1

**Table 2: STR8 Power Supply Current**

All motors connected in parallel, except HT24 which have four leads.

Switch	Motor	Drive Current Amps, peak of sine	Max Power Supply Current (A)		
			24VDC	48VDC	60VDC
0	reserved for custom motors				
1					
2					
3	HT23-603	6	4.4	4.0	4.0
4	HT23-394/594	3.4	1.9	2.0	n/a
5	HT23-398/598	5	3.2	3.3	n/a
6	HT23-401/601	5	3.2	3.4	n/a
7	HT24-100	3.36	2.6	2.3	2.0
8	HT24-105	4.8	5.2	3.2	2.7
9	HT24-108	4.8	4.3	3.4	2.9
A	HT34-485	8	5.1	5.0	5.0
B	HT34-486	8	5.2	4.6	4.4
C	HT34-487	8	5.2	5.4	5.3
D	HT34-504	7.56	4.8	4.2	4.0
E	HT34-505	7.56	4.4	4.2	4.2
F	HT34-506	6.72	3.5	3.2	3.3

### Regeneration

If you plan to use a regulated power supply you may encounter a problem with regeneration. If you rapidly decelerate a load from a high speed, much of the kinetic energy of that load is transferred back to the power supply. This can trip the overvoltage protection of a switching power supply, causing it to shut down. If you have a high inertia load running at high speed an unregulated supply may be better. It has large capacitors for storing energy coming back from the drive. They are also less expensive. See previous section on *Connecting the Power Supply* for details on the RC-050 regeneration clamp.

## Connecting the Motor

**⚠ Never connect or disconnect the motor while the power is on.**

*If the motor has a shield or grounding wire, please connect it to the chassis ground screw located on the chassis near the motor-power connector.*



**Chassis Ground Screw**

### Four Lead Motor

These motors can only be connected one way. Please follow the sketch below.

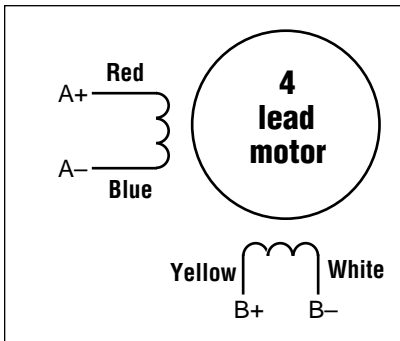

**4 Leads**

### MOTOR/POWER CONNECTOR

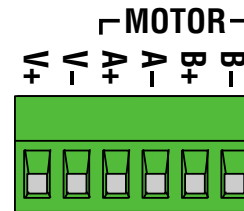

### Eight Lead Motor

These motors can be connected in series or parallel. A series connected motor needs less current than one that is connected in parallel but it will not be able to run as fast. Once you have determined which way you want to connect your motor to the drive, please follow the wiring diagrams below.

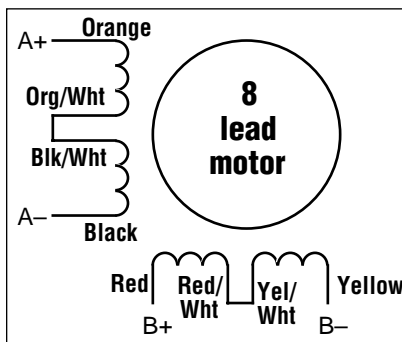

**8 Leads Series Connected**

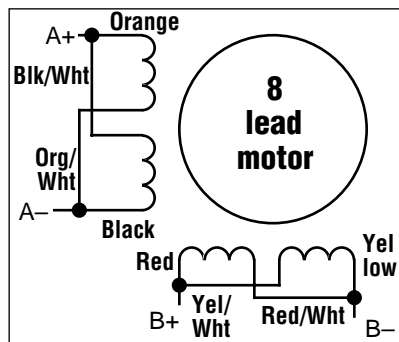

**8 Leads Parallel Connected**

## Connecting Input Signals

The STR drives have three inputs:

- STEP: a high speed digital input for step pulse commands, 5-24 volt logic
- DIR: a high speed digital input for the direction signal, 5-24 volt logic
- EN: a 5-24V input for removing power from the step motor. When the EN input is activated the motor is disabled. Activating then de-activating the EN input clears alarms and faults, and re-enables the motor in the case of drive faults.

## Connector Pin Diagram

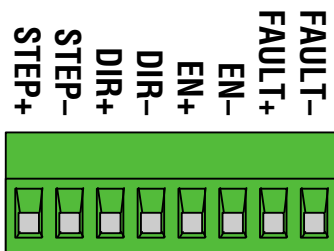

## Internal Circuit Diagram

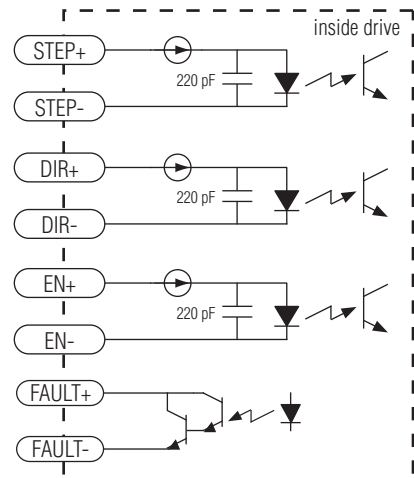

## Connection Examples: STEP & DIR

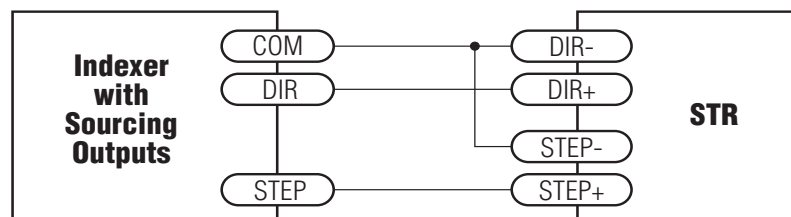

Connecting to indexer with Sourcing Outputs

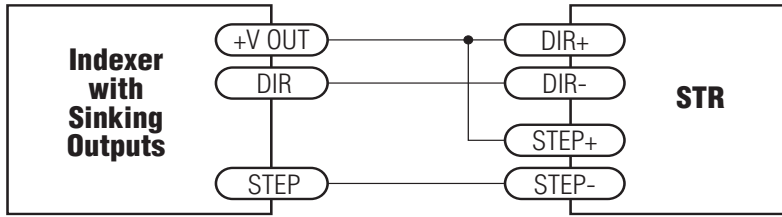

**Connecting to Indexer with Sinking Outputs**

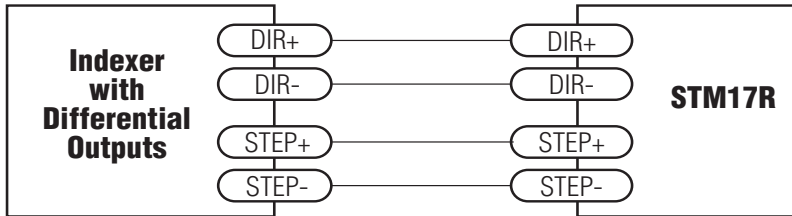

**Connecting to Indexer with Differential Outputs**  
(Many High Speed Indexers have Differential Outputs)

## Connection Examples: EN

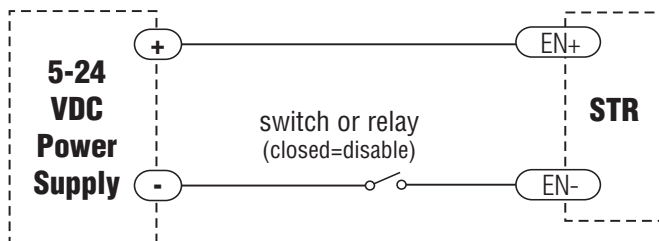

**Connecting an Input to a Switch or Relay**

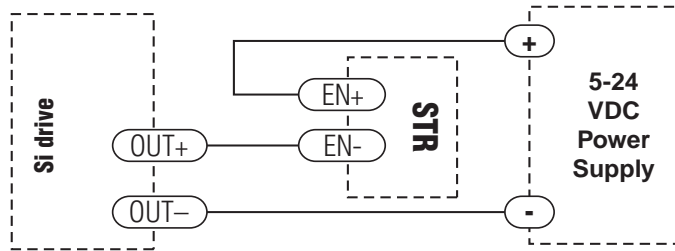

### Connecting another drive to EN

*(When output closes, the drive disables)*

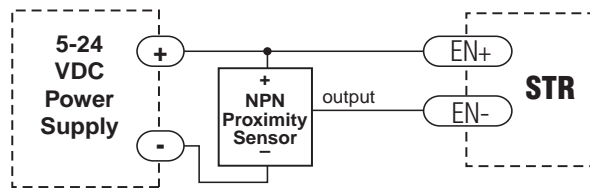

### Connecting an NPN Type Proximity Sensor to an input

*(When prox sensor activates, the drive disables)*

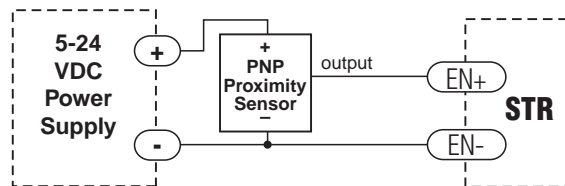

### Connecting a PNP Type Proximity Sensor to an input

*(When prox sensor activates, the drive disables)*

## FAULT Output

The STR drives feature a digital FAULT output. This output closes to signal a fault condition.

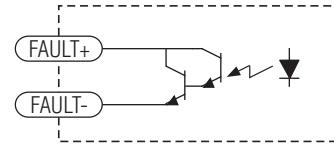

This output can be used to drive LEDs, relays and the inputs of other electronic devices like PLCs. The "+" (collector) and "-" (emitter) terminals of the output transistor are available at the connector. This allows you to configure the output for current sourcing or sinking.



Diagrams of each type of connection follow.

***Do not connect the output to more than 30VDC.***

***The current through the output terminal must not exceed 80 mA.***

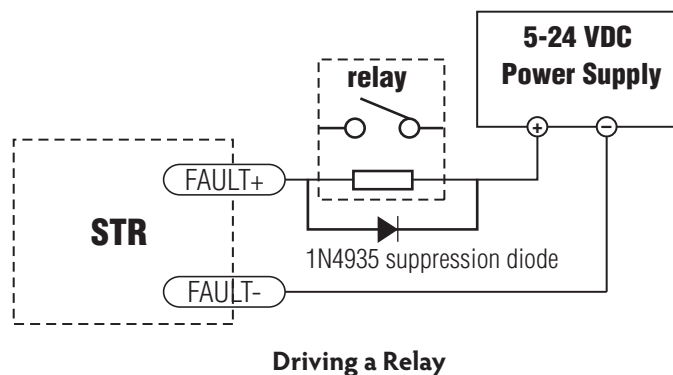
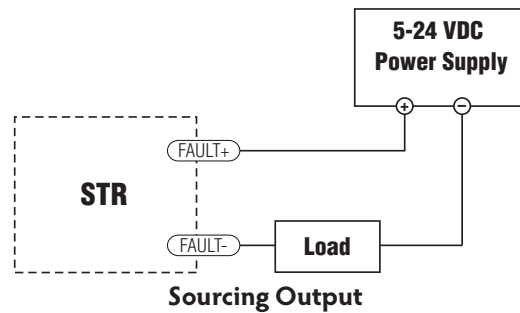
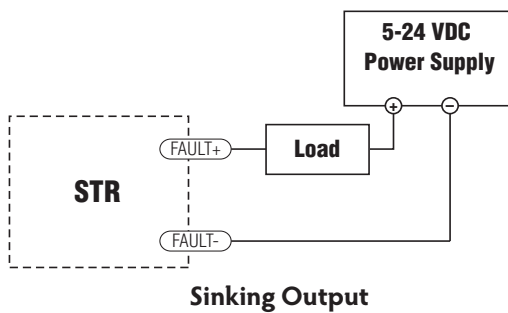



## Configuring the Drive

### Step 1: Selecting a Motor

The STR drives are optimized for use with carefully selected motors. To select a motor, simply move the rotary switch to the letter or number that corresponds to the motor of your choice. You can do this while power is on, but it is safer to select the motor before applying power to the drive so that you do not risk applying too much current to your motor.

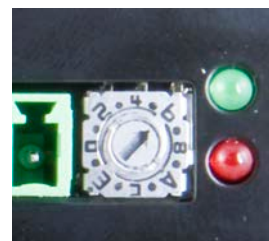

If your motor is not on the list, please set the switch to a selection whose rotor inertia, holding torque and current are within 10% of your motor. Custom configurations can be added for qualifying applications.

### STR4 Motor Table

Switch	Motor	Wiring	Drive Current Amps, peak of sine	Holding Torque oz-in	Rotor Inertia g-cm <sup>2</sup>
0	reserved for custom configurations				
1					
2	HT17-278	parallel	2.4	113	123
3	HT17-068/268	parallel	1.6	31.4	35
4	HT17-071/271	parallel	2	51	54
5	HT17-075/275	parallel	2	62.8	68
6	HT23-394/594	parallel	3.4	76.6	120
7	HT23-398/598	parallel	4.5	159.3	300
8	HT23-401/601	parallel	4.5	237.6	480
9	HT24-100	4 leads	3.36	123	280
A	HT24-105	4 leads	4.5	166	450
B	HT24-108	4 leads	4.5	332	900
C	HT34-485	series	4.5	585	1400
D	HT34-486	series	4.5	1113	2680
E	HT34-504	series	3.816	396	1100
F	HT34-505	series	3.816	849	1850

**STR8 Motor Table**

Switch	Motor	Wiring	Drive Current Amps, peak of sine	Holding Torque oz-in	Rotor Inertia g-cm <sup>2</sup>
0	reserved for custom configurations				
1					
2					
3	HT23-603	parallel	6	354	750
4	HT23-394/594	parallel	3.4	76.6	120
5	HT23-398/598	parallel	5	177	300
6	HT23-401/601	parallel	5	264	480
7	HT24-100	4 leads	3.36	123	280
8	HT24-105	4 leads	4.8	177	450
9	HT24-108	4 leads	4.8	354	900
A	HT34-485	parallel	8	507	1400
B	HT34-486	parallel	8	965	2680
C	HT34-487	parallel	8	1439	4000
D	HT34-504	parallel	7.56	396	1100
E	HT34-505	parallel	7.56	849	1850
F	HT34-506	parallel	6.72	1260	2750

**Step 2: Setting the Current**

The maximum current for the motor you have selected is set automatically when you set the rotary switch. But you may want to reduce the current to save power or lower motor temperature. This is important if the motor is not mounted to a surface that will help it dissipate heat or if the ambient temperature is expected to be high.

Step motors produce torque in direct proportion to current, but the amount of heat generated is roughly proportional to the square of the current. If you operate the motor at 90% of rated current, you'll get 90% of the rated torque. But the motor will produce approximately 81% as much heat. At 70% current, the torque is reduced to 70% and the heating to about 50%.

Two of the small DIP switches on the front of the STR drive are used to set the percent of rated

current that will be applied to the motor: SW1 and SW2. Please set them according to the illustration below.

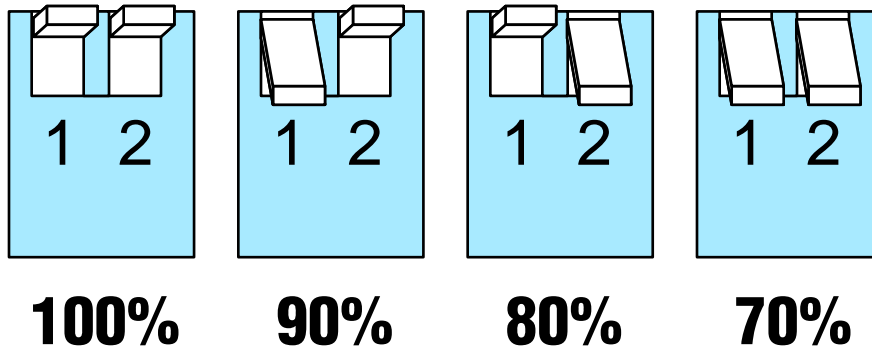

### Step 3: Setting Idle Current

Motor heating and power consumption can also be reduced by lowering the motor current when it is not moving. The STR will automatically lower the motor current when it is idle to either 50% or 90% of the running current. The 50% idle current setting will lower the holding torque to 50%, which is enough to prevent the load from moving in most applications. This reduces motor heating by 75%. In some applications, such as those supporting a vertical load, it is necessary to provide a high holding torque. In such cases, the idle current can be set to 90% as shown below.

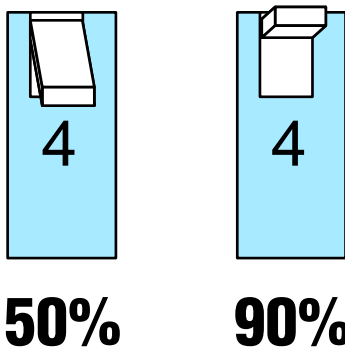

## Step 4: Load Inertia

The STR drives include anti-resonance and electronic damping features which greatly improve motor performance. To perform optimally, the drive must understand the electromechanical characteristics of the motor and load. Most of this is done automatically when you select the motor by setting the rotary switch. To further enhance performance, you must set a switch to indicate the approximate inertia ratio of the load and motor. The ranges are 0 to 4X and 5 to 10X. The motors table shown in Step 1 of this section include the rotor inertia of each motor. Please divide the load inertia by the rotor inertia to determine the ratio, then set switch 3 accordingly, as shown. For assistance in calculating the load inertia of your application contact our Applications department.

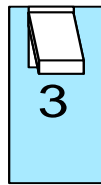

**5-10X**

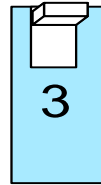

**0-4X**

## Step 5: Step Size

The STR requires a source of step pulses to command motion. This may be a PLC, an indexer, a motion controller or another type of device. The only requirement is that the device be able to produce step pulses whose frequency is in proportion to the desired motor speed, and be able to smoothly ramp the step speed up and down to produce smooth motor acceleration and deceleration.

Smaller step sizes result in smoother motion and more precise speed, but also require a higher step pulse frequency to achieve maximum speed. The smallest step size of the STR drives is 1/20,000th of a motor turn. To command a motor speed of 50 revolutions per second (3000 rpm) the step pulses frequency must be  $50 \times 20,000 = 1$  MHz. Many motion devices, especially PLCs cannot provide step pulses at such a high speed. If so, the drive must be set for a lower number of steps per revolution. Six different settings are provided in the STR drive, as shown in the table on the next page.

Please choose the one that best matches the capability of your system.

At lower step resolutions such as 200 steps/ rev (full step) and 400 steps/rev (half step), motors run a little rough and produce more audible noise than when they are microstepped (2000 steps/rev and beyond). The STR drives include a feature called "microstep emulation", also called "step smoothing", that can provide smooth motion from coarse command signals. If you select "200 SMOOTH" or "400 SMOOTH", this feature is automatically employed to provide the smoothest possible motion from a less than ideal signal source.

Because a command filter is used as part of the step smoothing process, there will be a slight delay, or "lag" in the motion. If this delay is objectionable for your application, please choose the non-filtered setting "200" or "400". The chart on the next page shows an example of the delay that can occur from using the step smoothing filter.

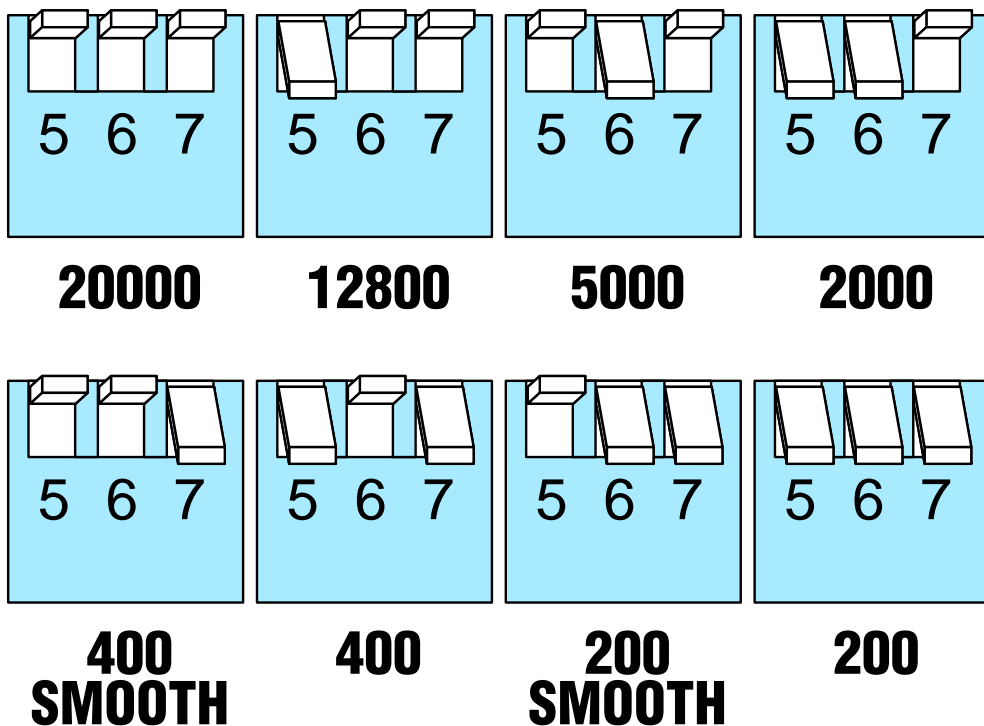

### Motion Profile with Step Smoothing Filter

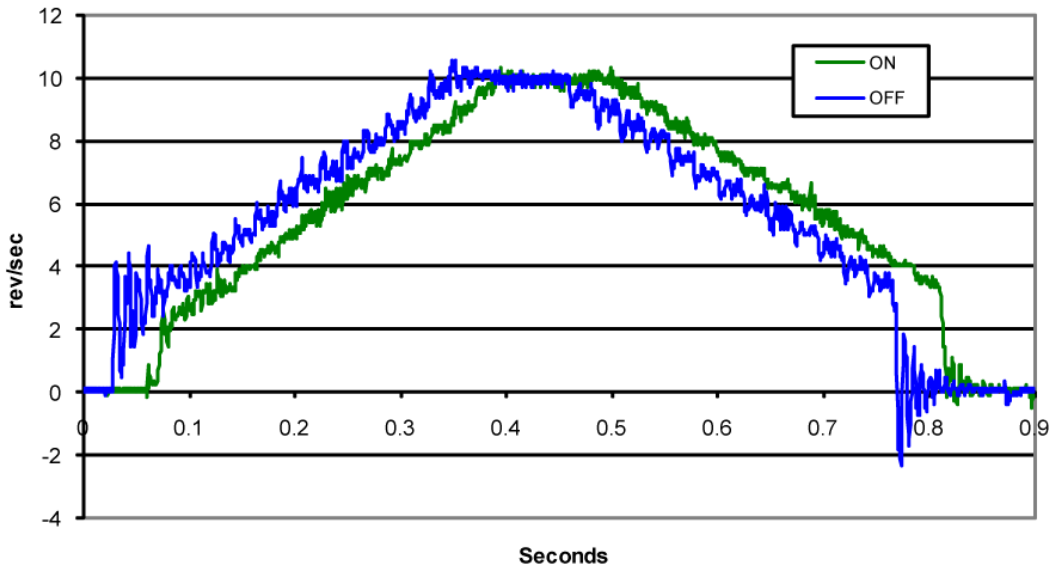

## Step 6: Step Pulse Type

Most indexers and motion controllers provide motion commands in the “Step and Direction” format. The Step signal pulses once for each motor step and the direction signal commands direction. However, a few PLCs use a different type of command signal: one signal pulses once for each desired step in the clockwise direction (called STEP CW), while a second signal pulses for counterclockwise motion (STEP CCW).

The STR drives can accept this type of signal if you remove the drive cover and move jumper S3 from the “1-2” position to the “1-3” position. In STEP CW/STEP CCW mode, the CW signal should be connected to the STEP input and the CCW signal to the DIR input.

### S3 Jumper settings

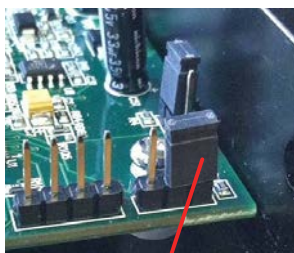

1-2: Step & Direction

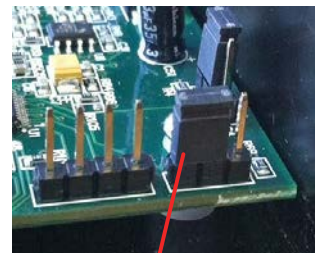

1-3: STEP CW & STEP CCW

### Step 7: Step Pulse Noise Filter

Just when you thought there couldn't be any more to know about step signals, we present one more setting for your consideration. Electrical noise can affect the STEP signal in a negative way, causing the drive to think that one step pulse is two or more pulses. This results in extra motion and inaccurate motor and load positioning. To combat this problem, the STR drives include a digital noise filter on the STEP and DIR inputs. The default factory setting of this filter is 150 kHz, which works well for most applications.

However, as discussed in Step 5, if you are operating the STR at a high number of steps/rev and at high motor speeds, you will be commanding the drive at step rates above 150 kHz. In such cases, you should remove the cover and move jumper S4 from the 150 kHz position (1-3) to the 2 MHz position (1-2) as shown below.

Your maximum pulse rate will be the highest motor speed times the steps/rev. For example, 40 revs/second at 20,000 steps/rev is  $40 \times 20,000 = 800$  kHz. Please consider this when deciding if you must increase the filter frequency.

#### S4 Jumper settings

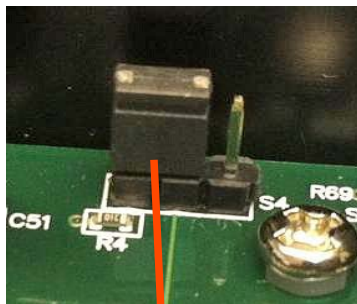

1-2: 2 MHz

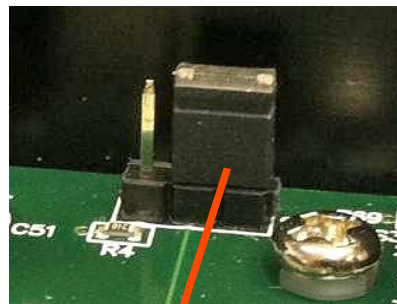

1-3: 150 kHz

## Self Test

If you are having trouble getting your motor to turn, you may want to try the built-in self test. Anytime switch 8 is moved to the ON position, the drive will automatically rotate the motor back and forth, two turns in each direction. This feature can be used to confirm that the motor is correctly wired, selected and otherwise operational.

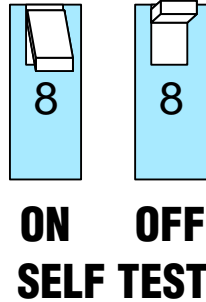

## Reference Materials

### Motor Outlines

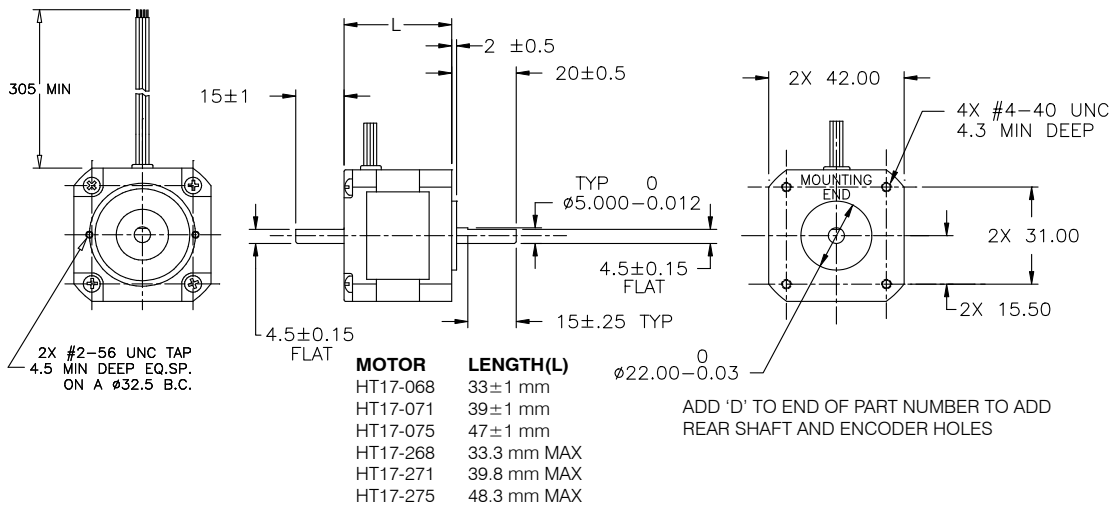

**HT17 Outline Drawing**



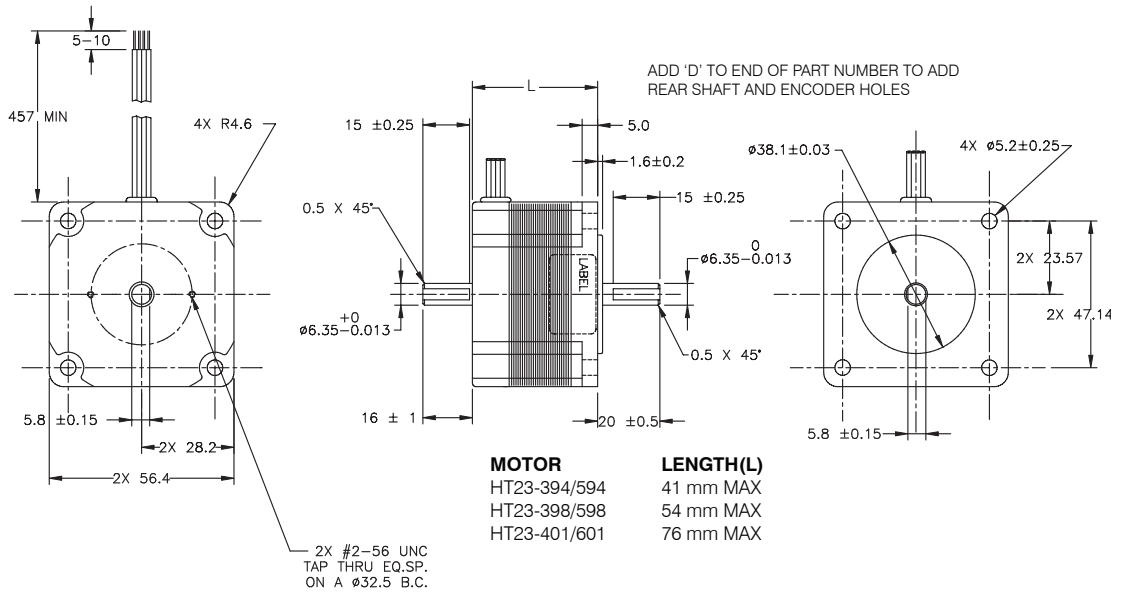

**HT23 Outline Drawing**

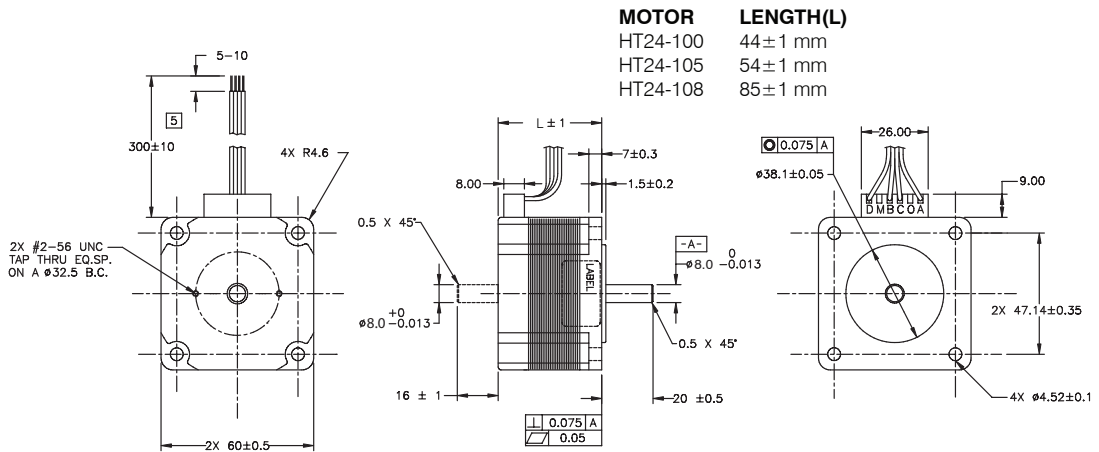

**HT24 Outline Drawing**

MOTOR	LENGTH(L)
HT34-504	66.5 ± 1 mm
HT34-505	96 ± 1 mm
HT34-506	125.5 ± 1 mm

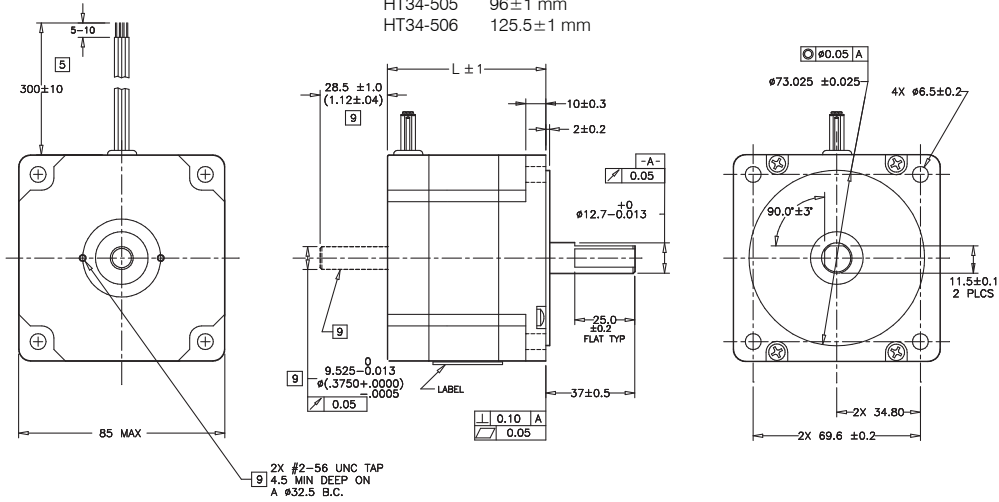

## HT34-504, 505 & 506 Outline Drawing

MOTOR	L MOTOR LENGTH	D SHAFT DIAMETER
HT34-485	79MM (3.11 IN ±0.04)	12.70 (.500 IN -0.005)
HT34-486	117MM (4.62 IN ±0.04)	12.70 (.500 IN -0.005)
HT34-487	156MM (6.14 IN ±0.04)	15.875 (.625 IN -0.005)

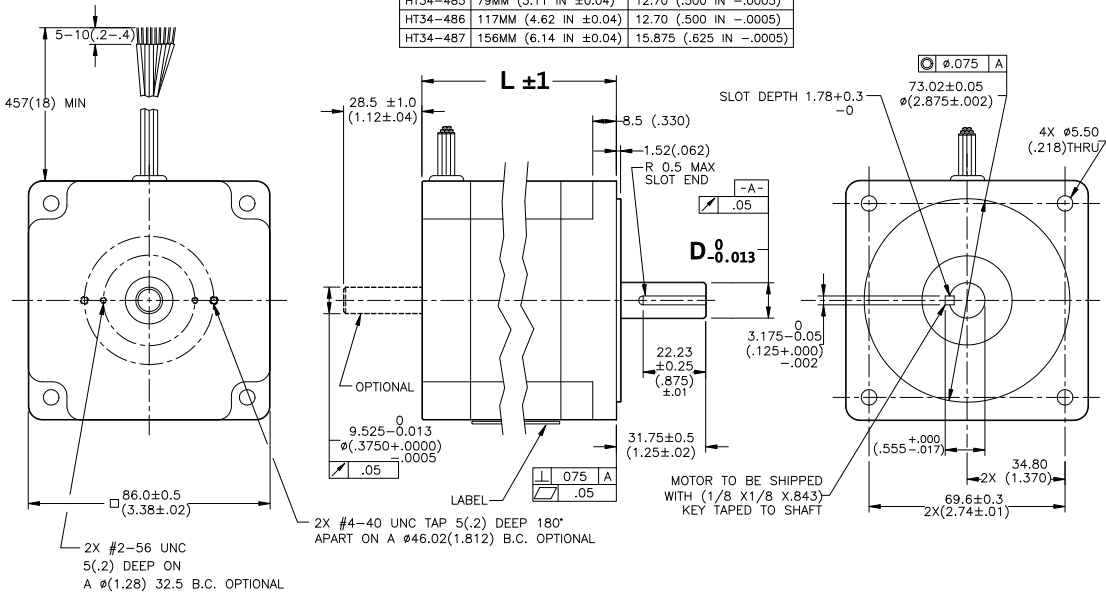

## HT34-485, 486, 487 Outline Drawing

## Torque-Speed Curves

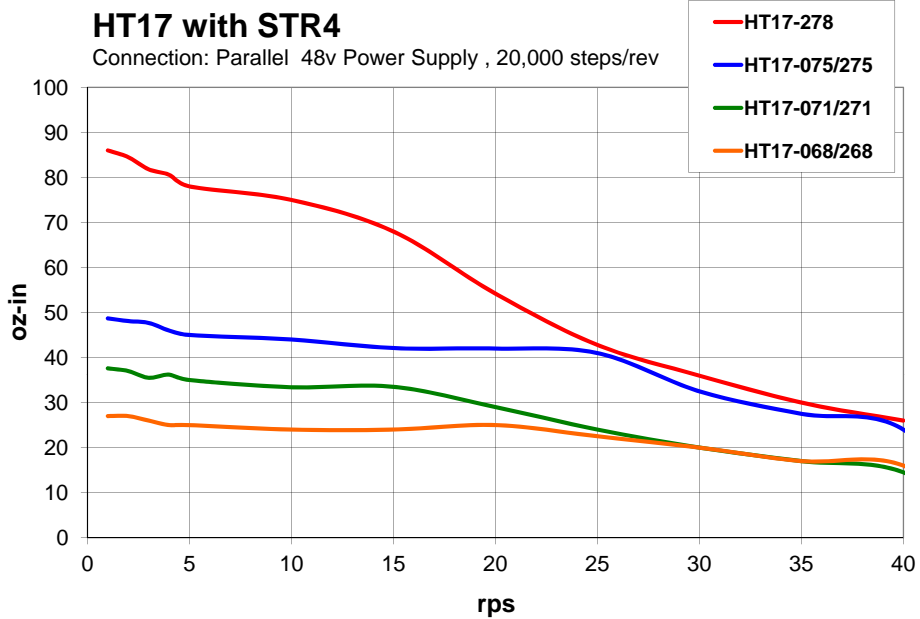
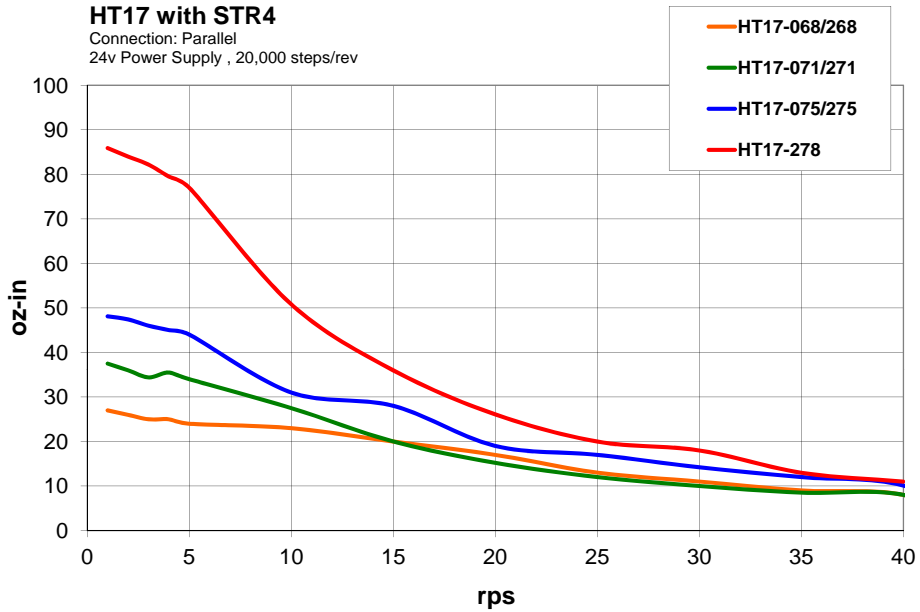

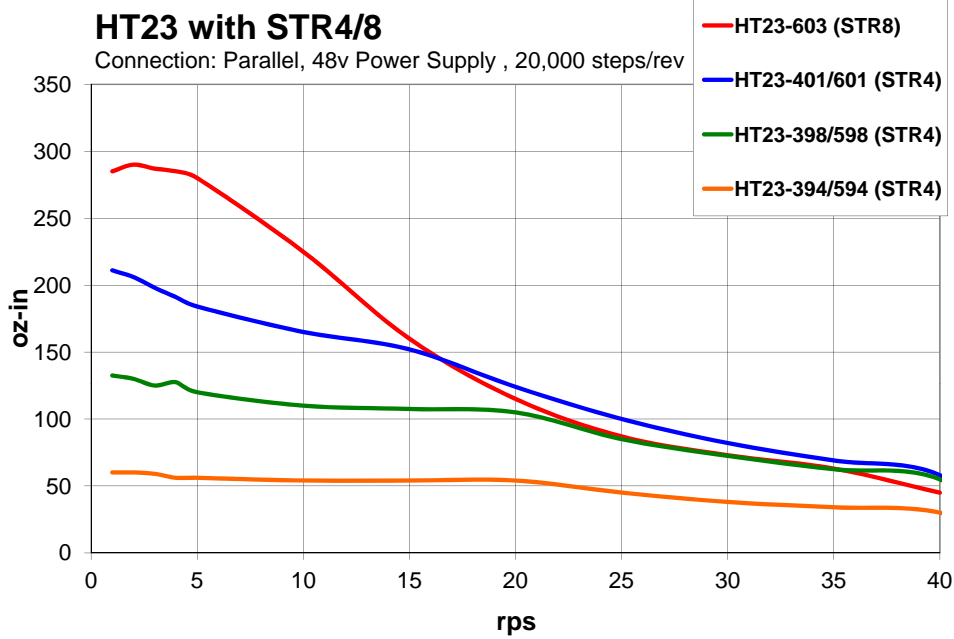
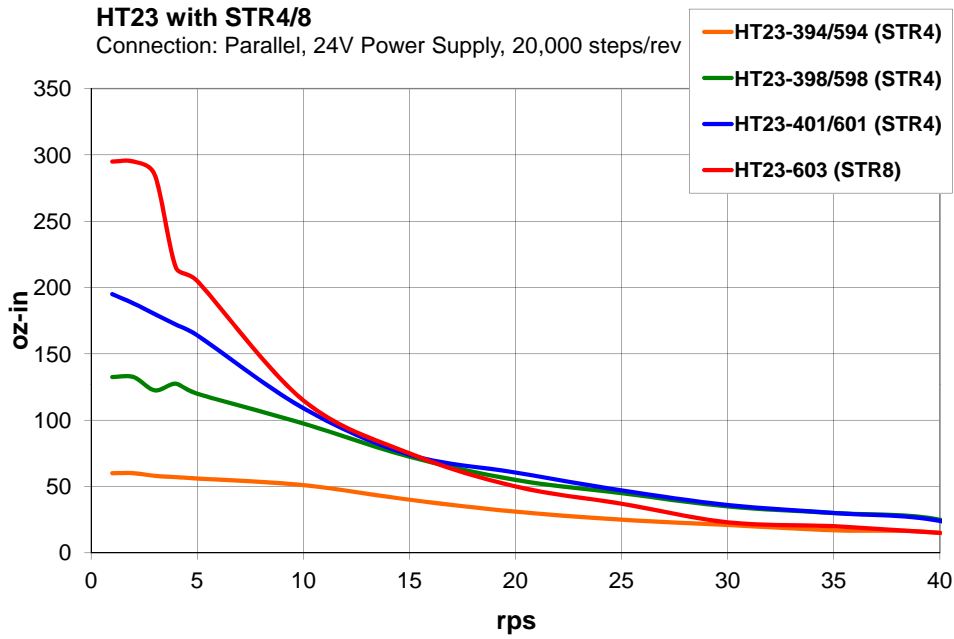

## HT24 with STR8

Connection: Parallel  
24v Power Supply , 20,000 steps/rev

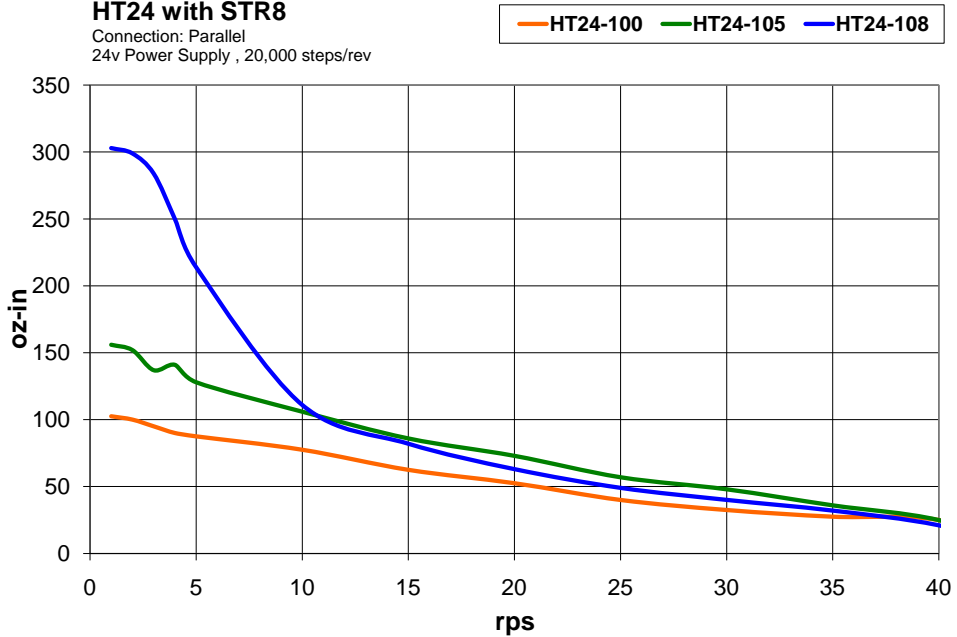

## HT24 with STR8

Connection: Parallel, 48v Power Supply , 20,000 steps/rev

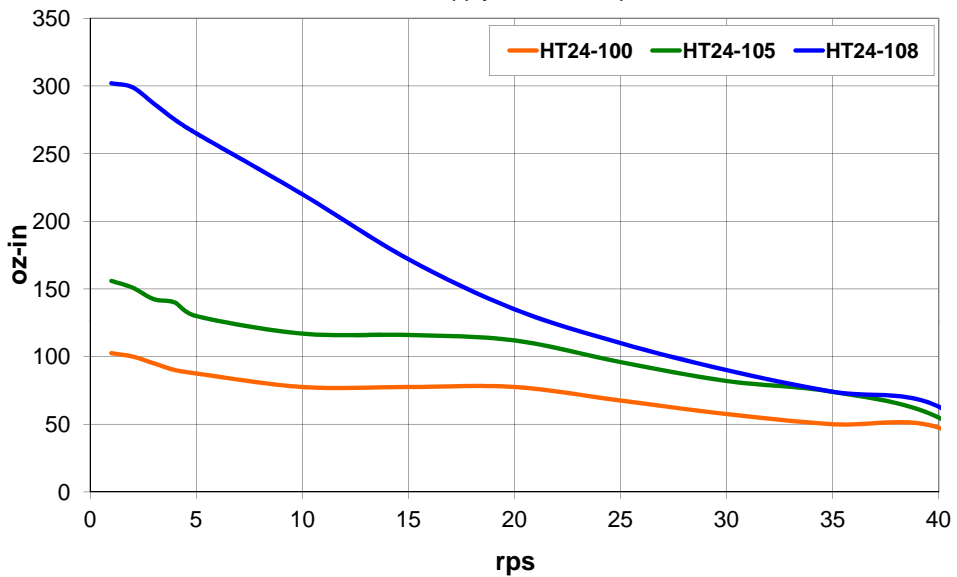

### HT34 with STR4

Connection: Series  
Power Supply 48V, 20,000 steps/rev

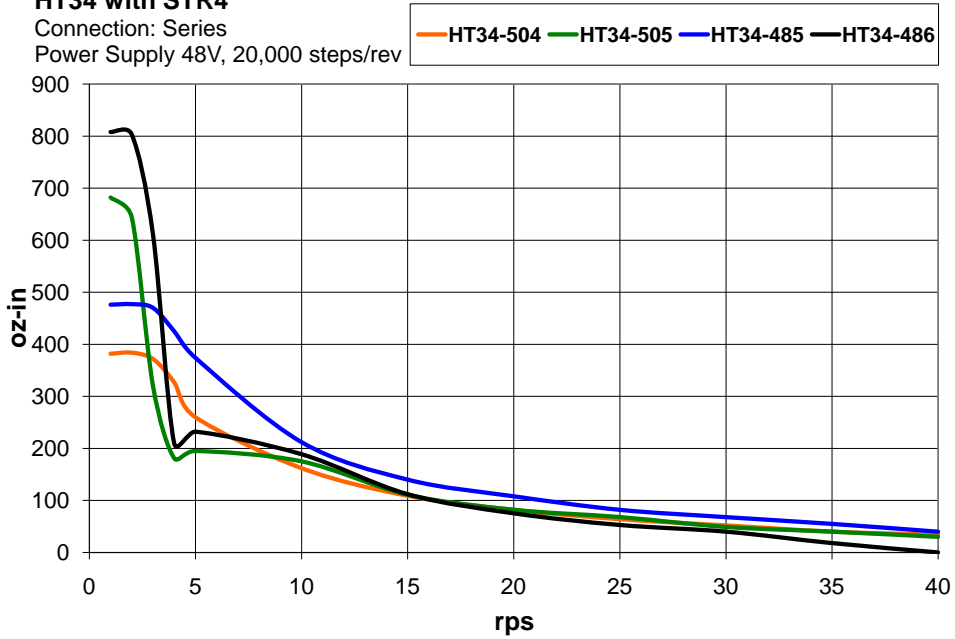

### HT34 with STR8

Connection: Parallel  
Power Supply 24V, 20,000 steps/rev

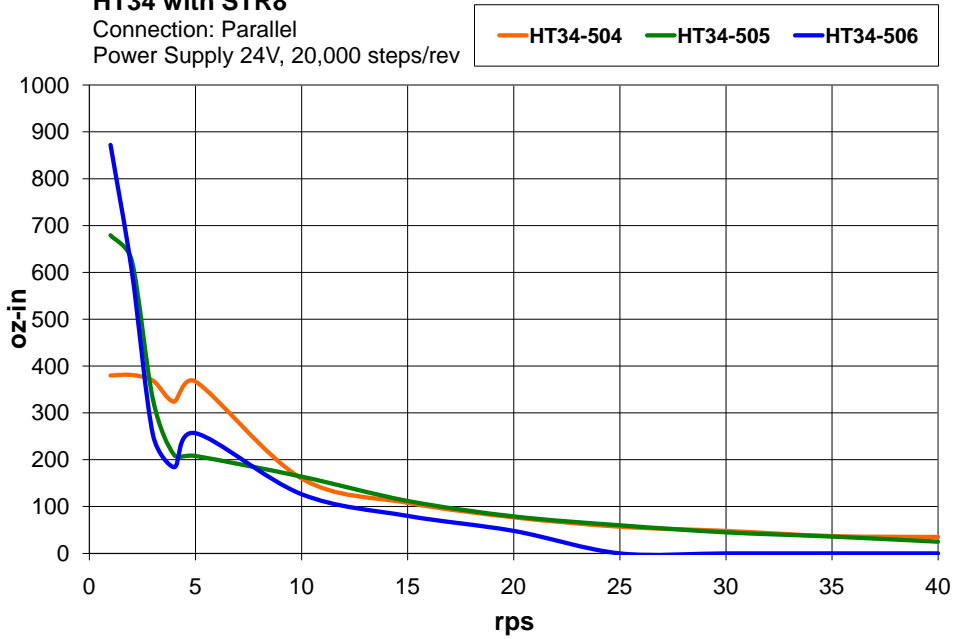

## HT34 with STR8

Connection: Parallel

Power Supply 48V, 20,000 steps/rev

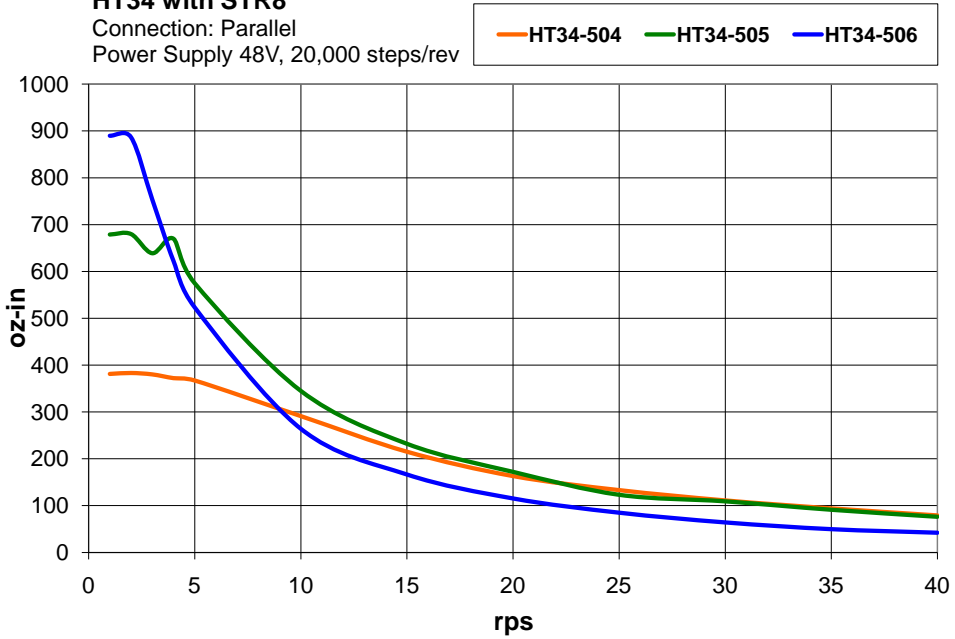

## HT34 with STR8

Connection: Parallel

Power Supply 60V, 20,000 steps/rev

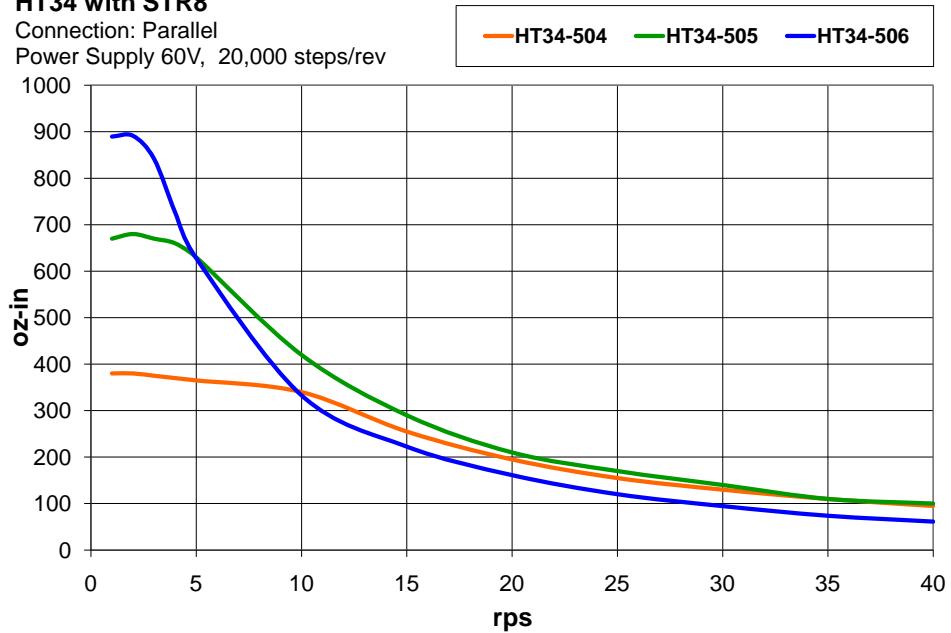

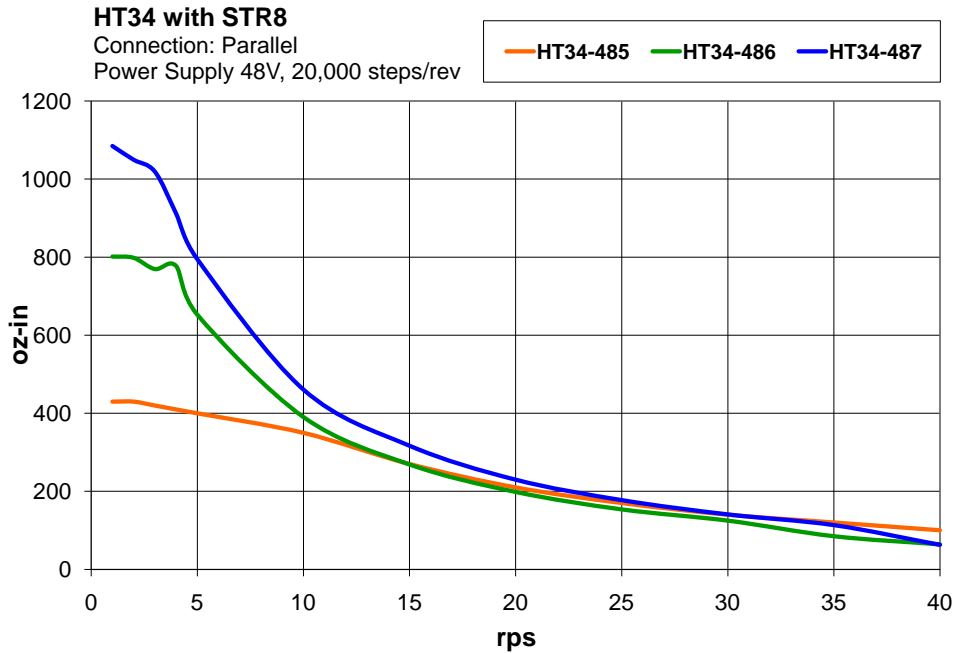
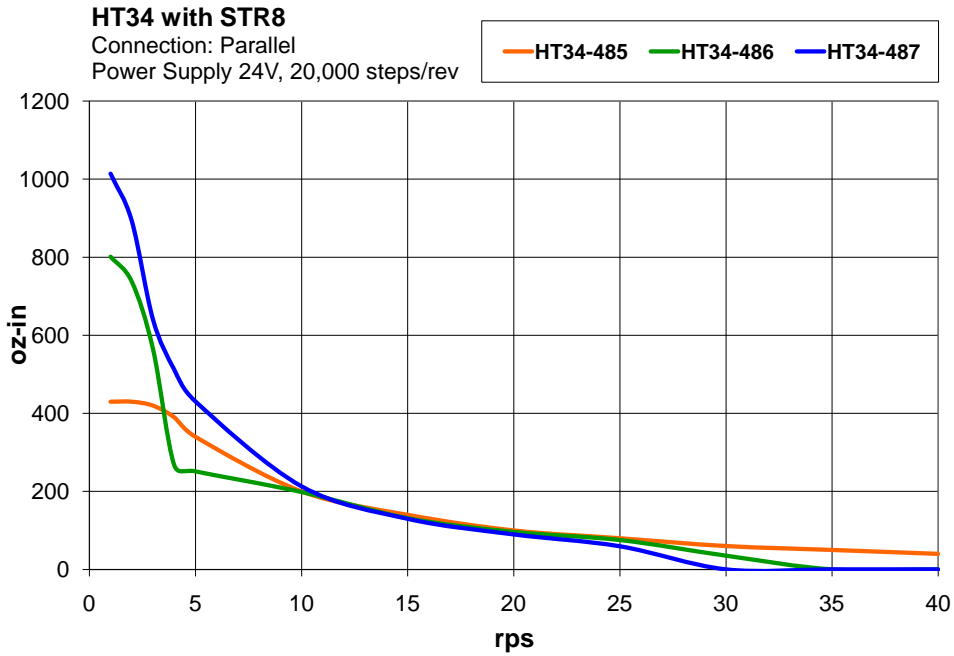



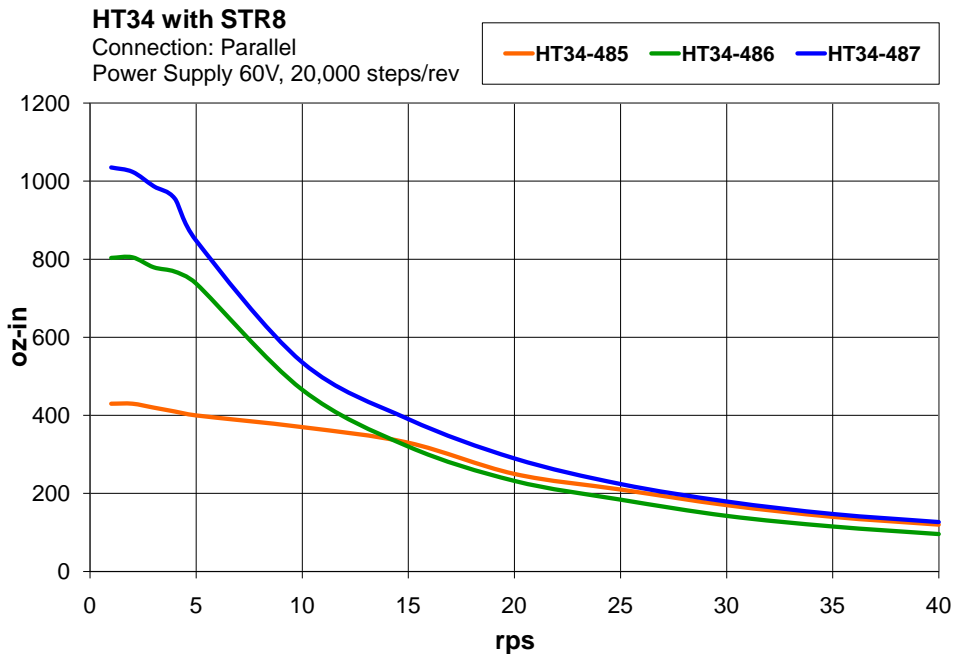

## Motor Heating

Step motors convert electrical power from the driver into mechanical power to move a load. Because step motors are not perfectly efficient, some of the electrical power turns into heat on its way through the motor. This heating is not so much dependent on the load being driven but rather the motor speed and power supply voltage. There are certain combinations of speed and voltage at which a motor cannot be continuously operated without damage.

We have characterized the recommended motors in our lab and provided curves showing the maximum duty cycle versus speed for each motor at commonly used power supply voltages. Please refer to these curves when planning your application.

Please also keep in mind that a step motor typically reaches maximum temperature after 30 to 45 minutes of operation. If you run the motor for one minute then let it sit idle for one minute, that is a 50% duty cycle. Five minutes on and five minutes off is also 50% duty. However, one hour on and one hour off has the effect of 100% duty because during the first hour the motor will reach full (and possibly excessive) temperature.

The actual temperature of the motor depends on how much heat is conducted, convected or radiated out of it. Our measurements were made in a 40°C (104°F) environment with the motor mounted to an aluminum plate sized to provide a surface area consistent with the motor power dissipation. Your results may vary.

## STR4 Maximum Motor Duty Cycle

Motor	Connection	Drive Current Amps, peak of sine	Max Duty Cycle at 40°C Ambient	
			24VDC	48VDC
HT17-068	parallel	1.6	100%	see chart
HT17-071	parallel	2	100%	see chart
HT17-075	parallel	2	see chart	see chart
HT17-268	parallel	1.6	100%	see chart
HT17-271	parallel	2	100%	see chart
HT17-275	parallel	2	100%	see chart
HT17-278	parallel	2.4	100%	see chart
HT23-394	parallel	3.4	100%	see chart
HT23-398	parallel	4.5	100%	see chart
HT23-401	parallel	4.5	100%	see chart
HT23-594	parallel	3.4	100%	see chart
HT23-598	parallel	4.5	100%	see chart
HT23-601	parallel	4.5	100%	see chart
HT24-100	4 leads	3.36	100%	100%
HT24-105	4 leads	4.5	100%	see chart
HT24-108	4 leads	4.5	100%	see chart
HT34-485	series	4.5	100%	100%
HT34-486	series	4.5	see chart	see chart
HT34-504	series	3.816	100%	100%
HT34-505	series	3.816	100%	100%

## STR8 Maximum Motor Duty

Motor	Connection	Drive Current Amps, peak of sine	Max Duty Cycle at 40°C Ambient		
			24VDC	48VDC	60VDC
HT23-394	parallel	3.4	100%	see chart	see chart
HT23-398	parallel	5	100%	see chart	see chart
HT23-401	parallel	5	100%	see chart	see chart
HT23-594	parallel	3.4	100%	see chart	see chart
HT23-598	parallel	5	100%	see chart	see chart
HT23-601	parallel	5	100%	see chart	see chart
HT23-603	parallel	6	100%	see chart	see chart
HT24-100	4 leads	3.36	100%	100%	see chart
HT24-105	4 leads	4.8	100%	see chart	see chart
HT24-108	4 leads	4.8	100%	see chart	see chart
HT34-485	parallel	8	100%	see chart	see chart
HT34-486	parallel	8	see chart	see chart	see chart
HT34-487	parallel	8	see chart	see chart	see chart
HT34-504	parallel	7.56	100%	100%	100%
HT34-505	parallel	7.56	100%	100%	see chart
HT34-506	parallel	6.72	100%	100%	100%

NR: power supply voltage is not recommended for this motor

**HT17-068 Max Duty cycle vs Speed**  
48 VDC, 1.60 Amps @Ambient of 40  
on 4.75 x 4.75 x .25 Aluminum Plate

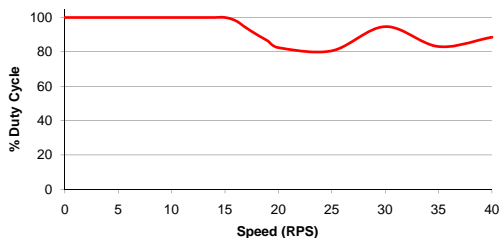

**HT17-071 Max Duty Cycle vs Speed**  
48 VDC, 2.0 Amps 40°C Ambient  
on 4.75 x 4.75 x .25 Aluminum Plate

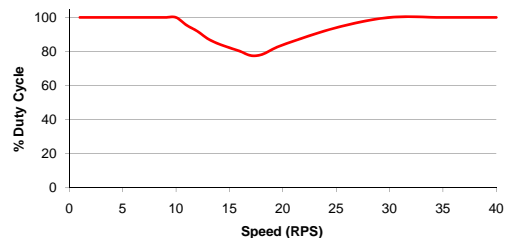

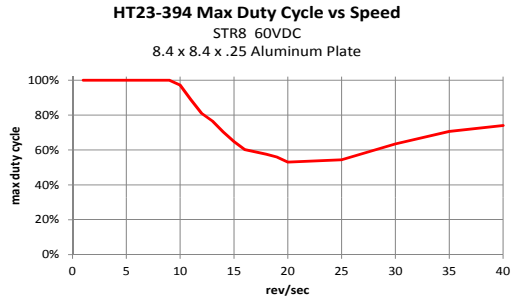
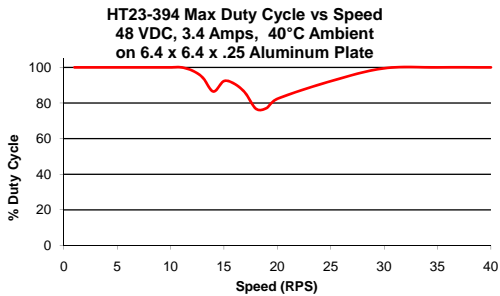
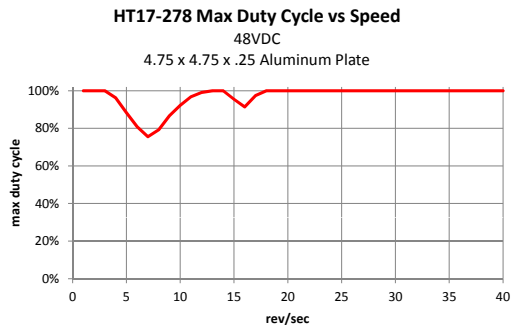
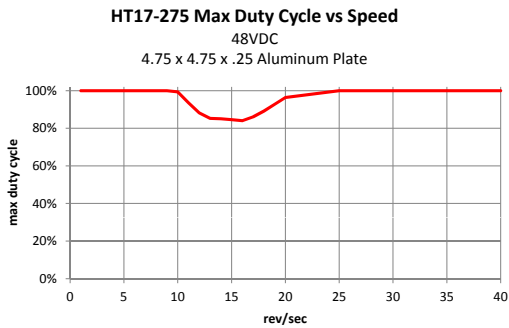
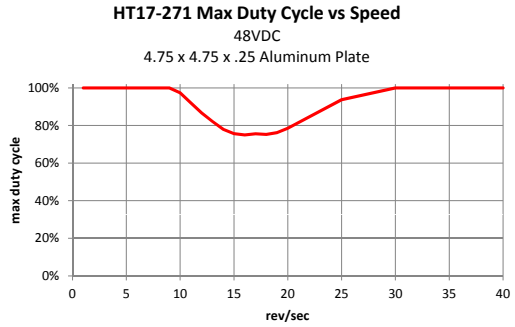
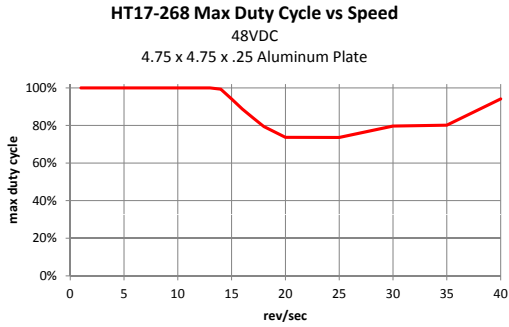
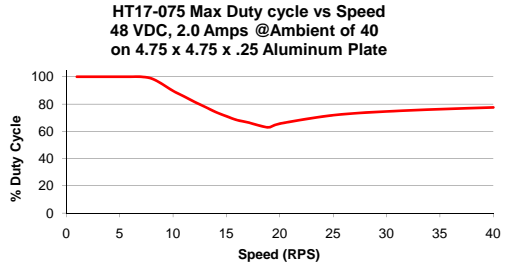
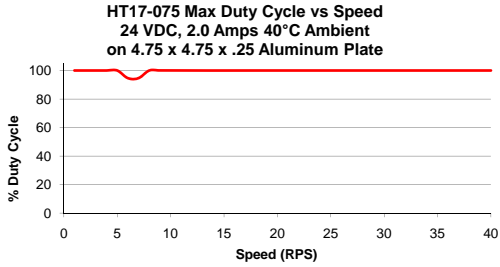

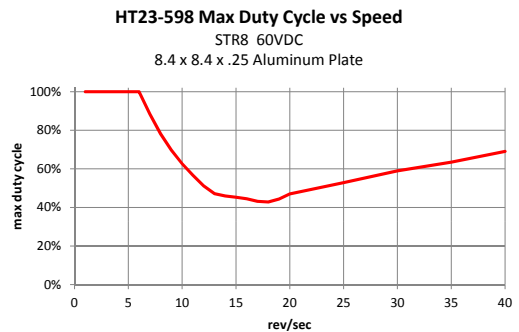
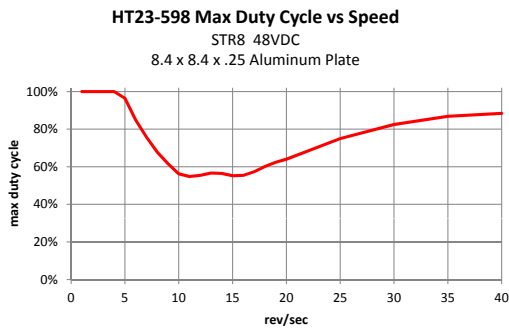
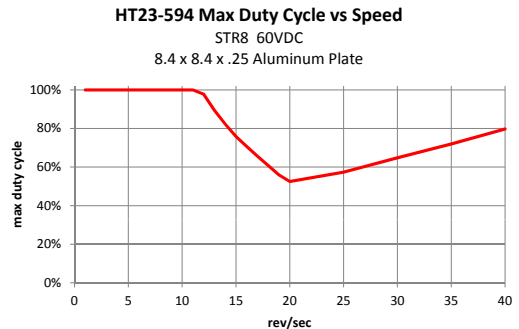
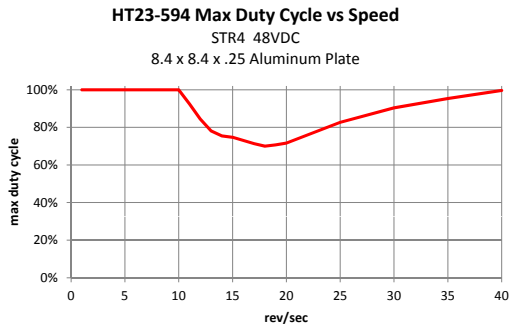
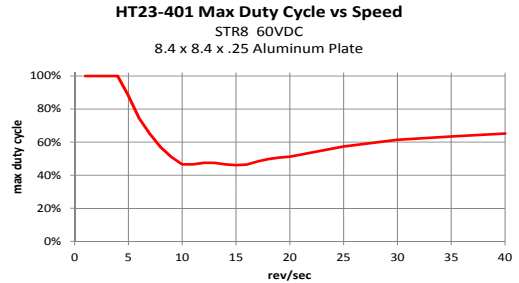
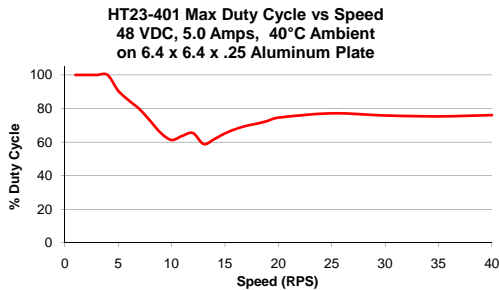
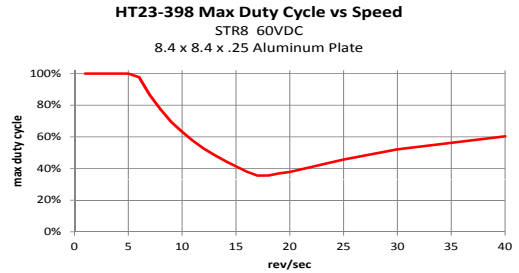
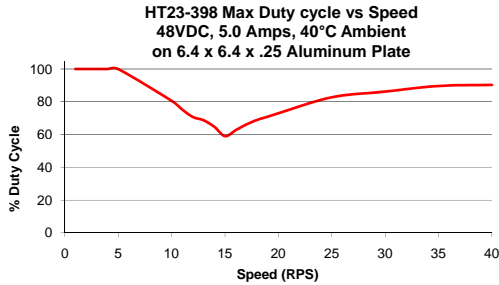

**HT23-601 Max Duty Cycle vs Speed**  
STR8 48VDC  
8.4 x 8.4 x .25 Aluminum Plate

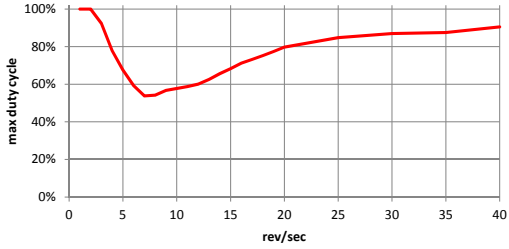

**HT23-601 Max Duty Cycle vs Speed**  
STR8 60VDC  
8.4 x 8.4 x .25 Aluminum Plate

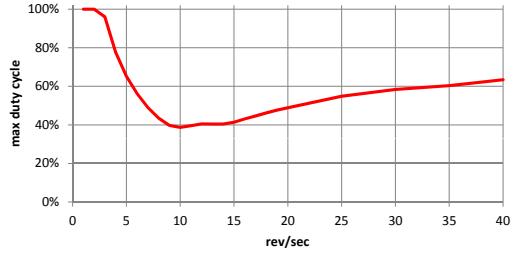

**HT23-603 Max Duty Cycle vs Speed**  
STR8 48VDC  
8.4 x 8.4 x .25 Aluminum Plate

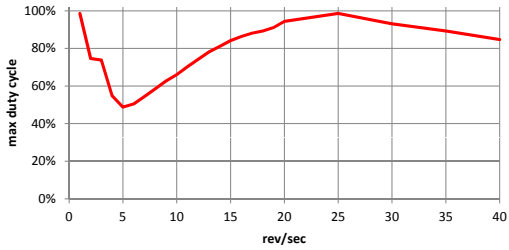

**HT23-603 Max Duty Cycle vs Speed**  
STR8 60VDC  
8.4 x 8.4 x .25 Aluminum Plate

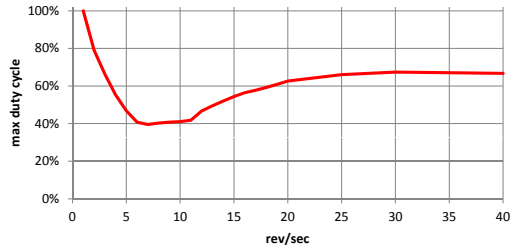

**HT24-100 Max Duty Cycle vs Speed**  
STR8 60VDC  
8.4 x 8.4 x .25 Aluminum Plate

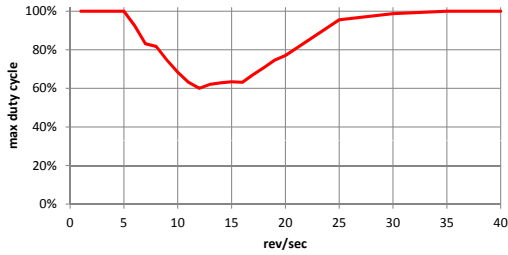

**HT24-105 Max Duty Cycle vs Speed**  
48VDC, 4.8A 40 °C Ambient  
on a 8.4 x 8.4 x .25 Aluminum Plate

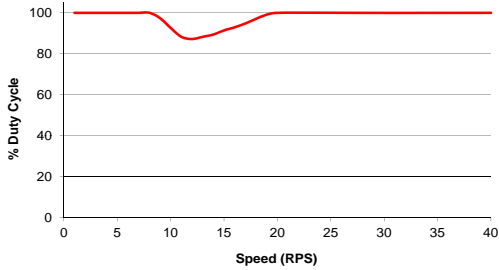

**HT24-105 Max Duty Cycle vs Speed**  
STR8 60VDC  
8.4 x 8.4 x .25 Aluminum Plate

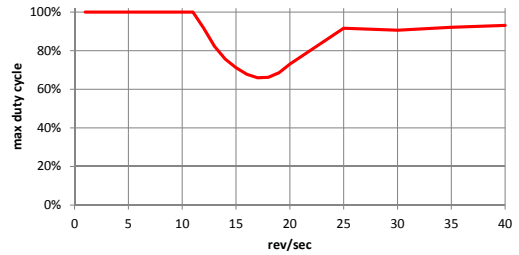

**HT24-108 Max Duty Cycle vs Speed**  
48VDC, 4.8A 40 °C Ambient  
on a 8.4 x 8.4 x .25 Aluminum Plate

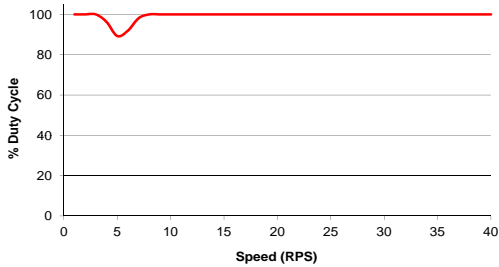

**HT24-108 Max Duty Cycle vs Speed**  
STR8 60VDC  
8.4 x 8.4 x .25 Aluminum Plate

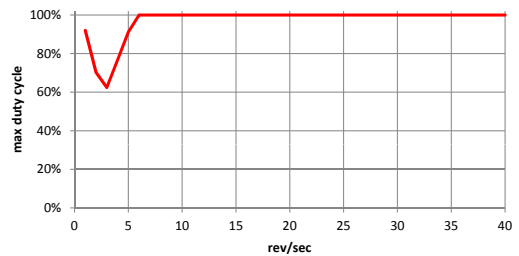

**HT34-485 Max Duty Cycle vs Speed**  
48VDC, 8A parallel 40 °C Ambient  
on a 10 x 10 x .5 Aluminum Plate

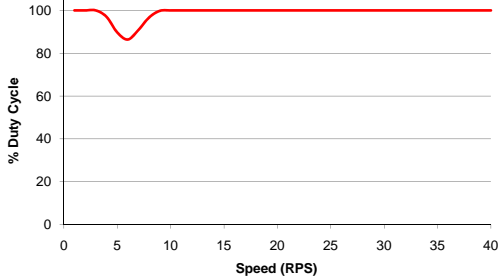

**HT34-485 Max Duty Cycle vs Speed**  
60VDC, 8A parallel 40 °C Ambient  
on a 10 x 10 x .5 Aluminum Plate

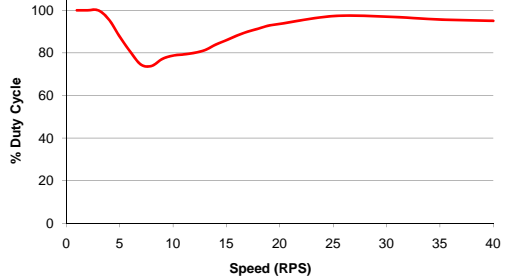

**HT34-486 Max Duty Cycle vs Speed**  
24VDC, 8A parallel 40 °C Ambient  
on a 10 x 10 x .5 Aluminum Plate

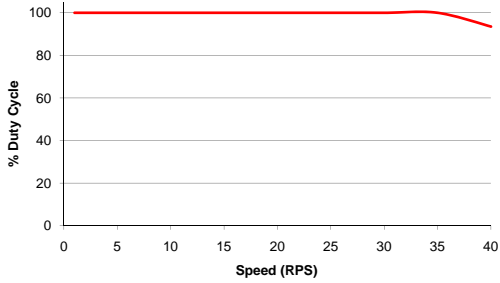

**HT34-486 Max Duty Cycle vs Speed**  
48VDC, 8A parallel 40 °C Ambient  
on a 10 x 10 x .5 Aluminum Plate

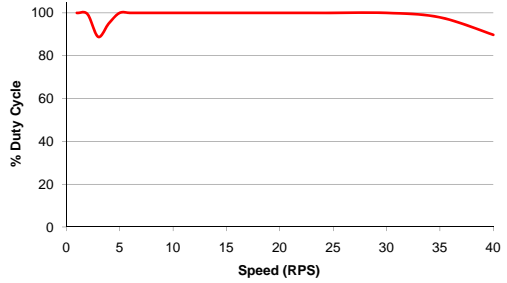

**HT34-486 Max Duty Cycle vs Speed**  
60VDC, 8A parallel 40 °C Ambient  
on a 10 x 10 x .5 Aluminum Plate

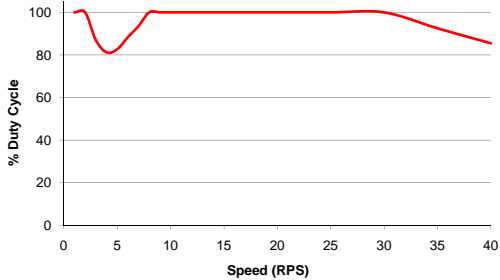



**HT34-486 Max Duty Cycle vs Speed**  
24VDC, 4.5A series 40 °C Ambient  
on a 10 x 10 x .5 Aluminum Plate

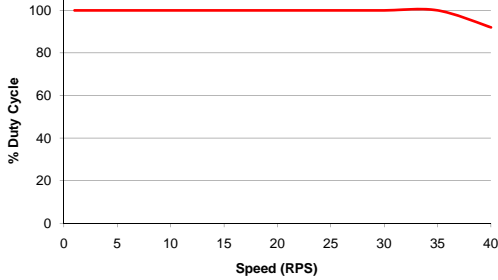

**HT34-486 Max Duty Cycle vs Speed**  
48VDC, 4.5A series 40 °C Ambient  
on a 10 x 10 x .5 Aluminum Plate

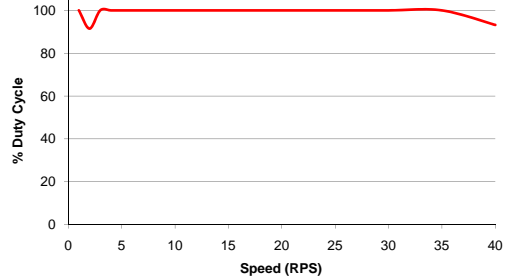

**HT34-487 Max Duty Cycle vs Speed**  
24VDC, 8A parallel 40 °C Ambient  
on a 10 x 10 x .5 Aluminum Plate

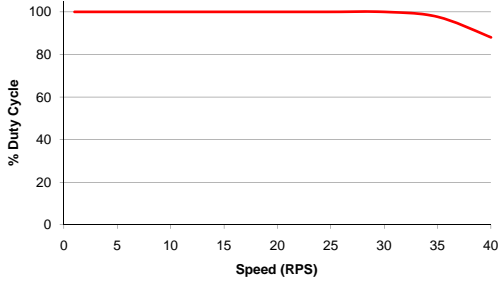

**HT34-487 Max Duty Cycle vs Speed**  
48VDC, 8A parallel 40 °C Ambient  
on a 10 x 10 x .5 Aluminum Plate

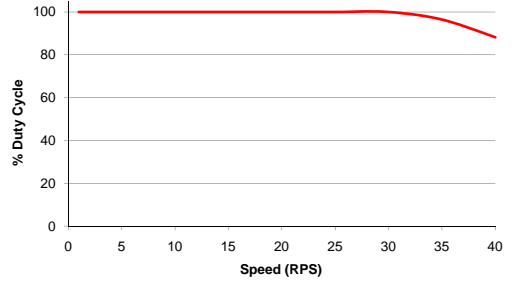

**HT34-487 Max Duty Cycle vs Speed**  
60VDC, 8A parallel 40 °C Ambient  
on a 10 x 10 x .5 Aluminum Plate

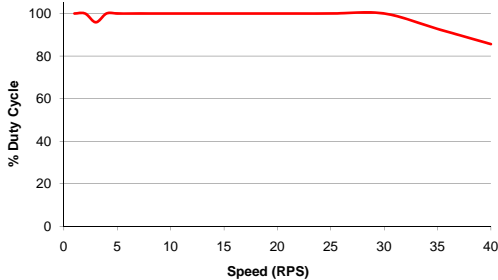

**HT34-505 Max Duty Cycle vs Speed**  
60VDC, 7.56A parallel 40 °C Ambient  
on a 10 x 10 x .5 Aluminum Plate

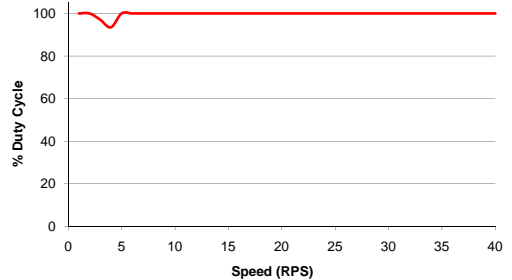

## Drive Heating

While STR drivers efficiently transmit power between the power supply and motor, they do generate some heat in the process. This will cause the temperature of the drive to rise above the surrounding air temperature and may also require that the drive be mounted to a heat conducting metal surface.

For those who wish to calculate the power dissipation and temperature rise, the following information is provided:

1. drive power dissipation  $P_d$  versus motor current and power supply voltage (see chart)
2. drive thermal constant  $R_{\theta}$

The final drive case temperature is given by

$$T_c = T_a + R_{\theta} * P_d$$

where  $T_a$  is the ambient temperature of the surrounding air. The case of the drive should not be allowed to exceed 70°C or the life of the product could be reduced.

Drive thermal constant:

Narrow side of drive mounted on a 13.5" x 13.5" steel plate, .070" thick:  $R_{\theta} = 1.0^{\circ}\text{C}/\text{W}$

Narrow side of drive mounted on a non-heat conducting surface:  $R_{\theta} = 2.1^{\circ}\text{C}/\text{W}$

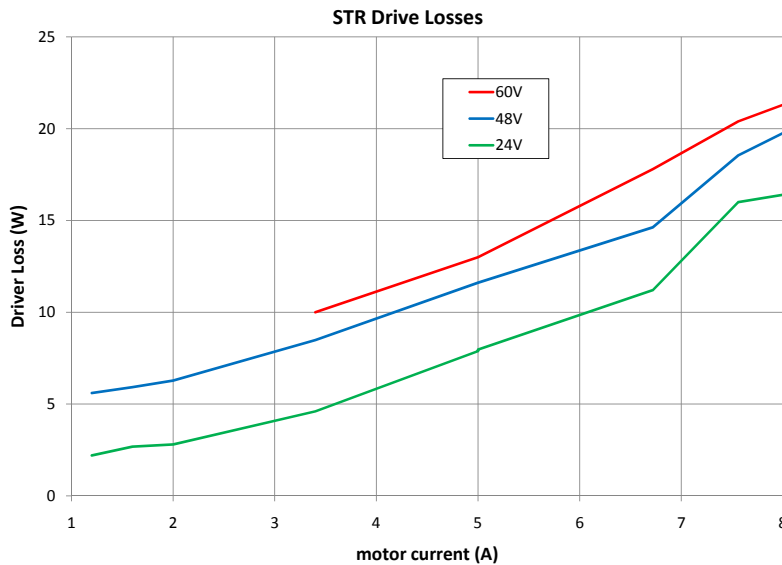

## Mechanical Outline

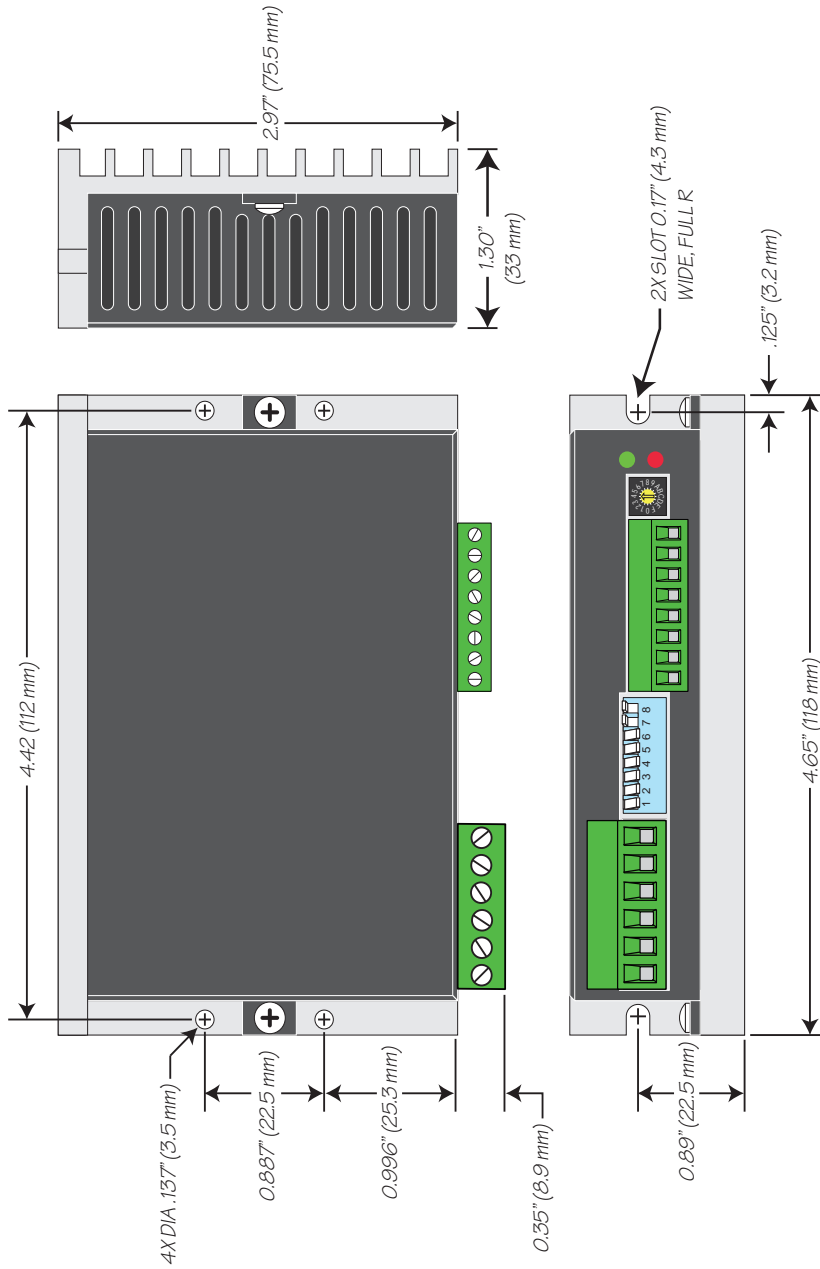

## Technical Specifications

**Amplifier** Digital MOSFET. 20 kHz PWM. Suitable for driving two phase and four phase step motors with four, six or eight leads.

Supply voltage:

**STR4**

24-48 VDC (STR4)

Under voltage alarm: 20 VDC

Over voltage shutdown: 60 VDC

**STR8**

24-75 VDC (STR8)

Under voltage alarm: 20 VDC

Over voltage shutdown: 85 VDC

Motor current:

(STR4) 1.12 (Rotary Sw3 X 70%) to 4.5 amps/phase peak of sine

(STR8) 2.35(Rotary Sw7 X 70%) to 8 amps/phase peak of sine

**Digital Inputs** Optically isolated, 5 - 24V logic. Sourcing, sinking or differential signals can be used. Drive steps on falling edge of STEP+ input.

Minimum "on" voltage: 4 VDC.

Maximum voltage: 30 VDC.

Input current: 5 mA typ at 4V, 15 mA typ at 30V.

Maximum pulse frequency: 150 kHz or 2 MHz (set by internal jumper)

Minimum pulse width:

3 usec (at 150 kHz setting)

0.25 usec (at 2 MHz setting)

**Fault Output** Photodarlington, 80 mA, 30 VDC max. Voltage drop: 1.2V max at 80 mA.

**Physical** 1.3 x 3.0 x 4.65 inches (33 x 75.5 x 118 mm) overall. 10.8 oz (305 g) including mating connectors.

Ambient temperature range: 0°C to 50°C.

## Mating Connectors and Accessories

### Mating Connectors

Motor/power supply: PCD P/N ELV06100 (Phoenix Contact 1757051), included with drive.  
Signals: PCD P/N ELVH08100 (Phoenix Contact 1803633), included with drive.

### Accessories

Regeneration Clamp:

Applied Motion Products [RC-050](#).

## Alarm Codes

In the event of a drive fault or alarm, the green LED will flash one or two times, followed by a series of red flashes. The pattern repeats until the alarm is cleared. Faults disable the motor and can be cleared by cycling power to the drive or toggling the enable input. The "power supply voltage too low alarm" does not disable the motor and will self-clear after 30 seconds. It can be cleared sooner by cycling power to the drive or toggling the enable input.

Code	Error
● solid green	no alarm, motor disabled
●● flashing green	no alarm, motor enabled
●●● flashing red	configuration or memory error; Contact factory for assistance.
●●●● 1 green, 4 red	power supply voltage too high fault
●●●●● 1 green, 5 red	over current / short circuit fault
●●●●●● 1 green, 6 red	open motor winding fault
●●●●●●● 2 green, 3 red	internal voltage out of range fault
●●●●●●●● 2 green, 4 red	power supply voltage too low alarm

## Connector Diagrams

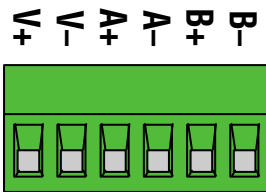

Power and Motor Connector

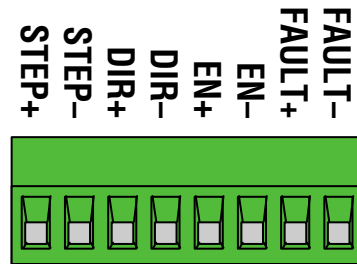

Signal Connector

404 Westridge Drive Watsonville, CA 95076  
 Tel (831) 761-6555 (800) 525-1609  
[www.applied-motion.com](http://www.applied-motion.com)